

2021

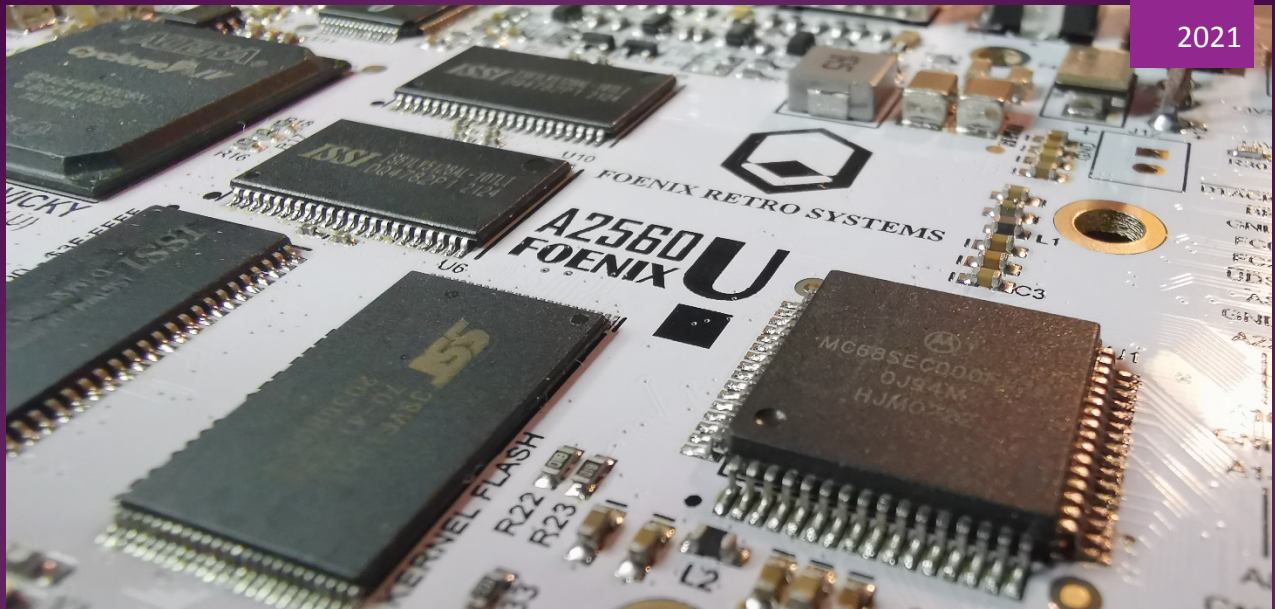

A2560 Foenix U

USER MANUAL

REVISION 0.0.2

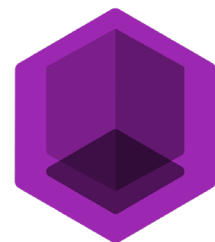

FOENIX RETRO SYSTEMS

A2560 FOENIX U - User Manual

Revision History	By	Rev	Date
Alpha Release - Preliminary	Stefany Allaire	0.0.0	Nov 16 th , 2021
RTC Registers / Interrupt Vector Update	Stefany Allaire	0.0.1	Dec 11 th , 2021
Timer Registers Update	Stefany Allaire	0.0.2	Dec 21 st , 2021

PRELIMINARY

Block Diagram



Memory Map

Addy Start Offset	Addy End	Size	Type	R/W	Description
0x000000	0x3FFFFFFF	8/16	MEM	R/W	System RAM - SRAM - 4Meg
0x400000	0xAFFFFFFF	-	-	-	Empty Space (will trigger an BERR if accessed)
0xB00000	0xB1FFFF	8/16/32	I/O	R/W	GAVIN Registers (System Controller)
0xB20000	0xB3FFFF	8/16/32	I/O	R/W	BEATRIX Registers (Sound/Music/DAC)
0xB40000	0xB5FFFF	8/16/32	I/O	R/W	VICKY II Registers (Text/Graphics Controller)
0xB60000	0xB63FFF	8/16	MEM	R/W	Text Memory Block
0xB64000	0xB67FFF	8/16	MEM	R/W	Text Color Memory Block
0xBF0000	0xBFFFFFFF	8/16	I/O/MEM	R/W	Expansion Bus Chip Select
0xC00000	0xDFFFFFFF	32	MEM	R/W	Video RAM - SRAM - 2Meg
0xE00000	0xFFFFFFFF	16	MEM	R	FLASH - 2Meg

PRELIMINARY

GAVIN Address Offset: 0x00B0

1. System Control Register

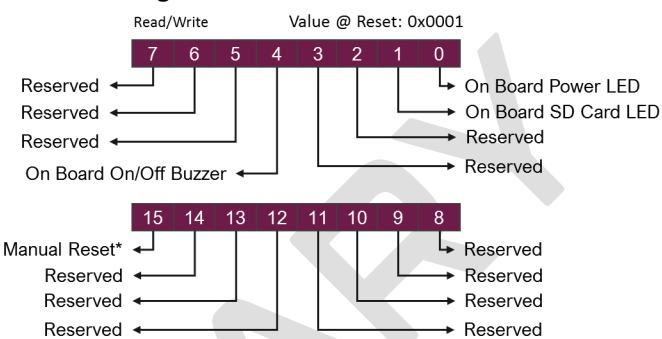
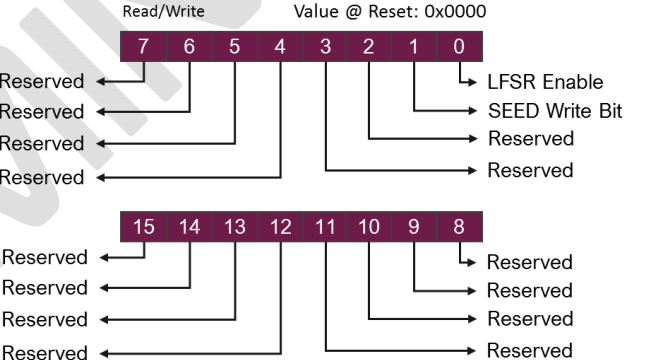
Addy Start Offset	Addy End	Size	Type	R/W	Description
0x0000		16	I/O	R/W	GAVIN Control Register Value @ Reset: 0x0001 
0x0002		16	I/O	R/W	Manual Reset - * Security Word Value @ Reset: 0x0000 Write the Value: 0xDEAD to unlock the Manual Reset
0x0004		16	I/O	R/W	LFSR Control Register Value @ Reset: 0x0000 
0x0006		16	I/O	R/W	LFSR SEED Value Write a Value to setup the LFSR Seed, then set bit#1 of LFSR Control Register. Then, clear the bit. This will latch the value of the Seed in the LFSR.
0x0008		16	I/O	R	LFSR Output Value Every time you read this register after the LFSR has been enabled and the Seed setup, you will get a new random value.
0x000A		16	I/O	R	LFSR Status Register

					<p>Read Only Value @ Reset: 0x0000</p> <p>7 6 5 4 3 2 1 0</p> <p>LFSR_DONE ← LFSR_CTRL[0]</p> <p>LFSR_CTRL[6] ← LFSR_CTRL[1]</p> <p>LFSR_CTRL[5] ← LFSR_CTRL[2]</p> <p>LFSR_CTRL[4] ← LFSR_CTRL[3]</p> <p>15 14 13 12 11 10 9 8</p> <p>0 ← 0</p> <p>0 ← 0</p> <p>0 ← 0</p> <p>0 ← 0</p>																																																																																																																																																																																																																												
0x000C	16	I/O	R	<p>Machine ID</p> <p>7 6 5 4 3 2 1 0</p> <p>CPU SPEED ID2 ← 1</p> <p>CPU SPEED ID1 ← 1</p> <p>CPU SPEED ID0 ← ID0 (Board Strap)</p> <p>Reserved ← ID1 (Board Strap)</p> <p>15 14 13 12 11 10 9 8</p> <p>CPU ID7 ← CPU ID0</p> <p>CPU ID6 ← CPU ID1</p> <p>CPU ID5 ← CPU ID2</p> <p>CPU ID4 ← CPU ID3</p> <p>Possible Value for Machine ID:</p> <table border="1"> <thead> <tr> <th>Machine</th> <th>Bit 3</th> <th>Bit 2</th> <th>Bit 1</th> <th>Bit 0</th> </tr> </thead> <tbody> <tr> <td>FMX</td> <td>0</td> <td>0</td> <td>0</td> <td>0</td> </tr> <tr> <td>C256U</td> <td>0</td> <td>0</td> <td>0</td> <td>1</td> </tr> <tr> <td>Reserved</td> <td>0</td> <td>0</td> <td>1</td> <td>0</td> </tr> <tr> <td>A2560 Dev</td> <td>0</td> <td>0</td> <td>1</td> <td>1</td> </tr> <tr> <td>GEN X</td> <td>0</td> <td>1</td> <td>0</td> <td>0</td> </tr> <tr> <td>C256U+</td> <td>0</td> <td>1</td> <td>0</td> <td>1</td> </tr> <tr> <td>Reserved</td> <td>0</td> <td>1</td> <td>1</td> <td>0</td> </tr> <tr> <td>Reserved</td> <td>0</td> <td>1</td> <td>1</td> <td>1</td> </tr> <tr> <td>A2560X</td> <td>1</td> <td>0</td> <td>0</td> <td>0</td> </tr> <tr> <td>A2560U</td> <td>1</td> <td>0</td> <td>0</td> <td>1</td> </tr> <tr> <td>Reserved</td> <td>1</td> <td>0</td> <td>1</td> <td>0</td> </tr> <tr> <td>A2560K</td> <td>1</td> <td>0</td> <td>1</td> <td>1</td> </tr> </tbody> </table> <p>Possible Value for CPU Speed ID:</p> <table border="1"> <thead> <tr> <th></th> <th colspan="3">SPEED ID</th> </tr> </thead> <tbody> <tr> <td>CPU SPEED ID</td> <td>2</td> <td>1</td> <td>0</td> </tr> <tr> <td>14.318Mhz</td> <td>0</td> <td>0</td> <td>0</td> </tr> <tr> <td>20.000Mhz</td> <td>0</td> <td>0</td> <td>1</td> </tr> <tr> <td>25.000Mhz</td> <td>0</td> <td>1</td> <td>0</td> </tr> <tr> <td>33.000Mhz</td> <td>0</td> <td>1</td> <td>1</td> </tr> <tr> <td>40.000Mhz</td> <td>1</td> <td>0</td> <td>0</td> </tr> <tr> <td>50.000Mhz</td> <td>1</td> <td>0</td> <td>1</td> </tr> <tr> <td>66.000Mhz</td> <td>1</td> <td>1</td> <td>0</td> </tr> <tr> <td>80.000Mhz</td> <td>1</td> <td>1</td> <td>1</td> </tr> </tbody> </table> <p>Possible Value for CPUID:</p> <table border="1"> <thead> <tr> <th rowspan="2">CPU</th> <th colspan="4">CPU Model</th> <th colspan="4">Speed Grade</th> </tr> <tr> <th>7</th> <th>6</th> <th>5</th> <th>4</th> <th>3</th> <th>2</th> <th>1</th> <th>0</th> </tr> </thead> <tbody> <tr> <td>MC68SEC000</td> <td>0</td> <td>0</td> <td>0</td> <td>0</td> <td>X</td> <td>X</td> <td>X</td> <td>X</td> </tr> <tr> <td>MC68020</td> <td>0</td> <td>0</td> <td>0</td> <td>1</td> <td>X</td> <td>X</td> <td>X</td> <td>X</td> </tr> <tr> <td>MC68EC020</td> <td>0</td> <td>0</td> <td>1</td> <td>0</td> <td>X</td> <td>X</td> <td>X</td> <td>X</td> </tr> <tr> <td>MC68030</td> <td>0</td> <td>0</td> <td>1</td> <td>1</td> <td>X</td> <td>X</td> <td>X</td> <td>X</td> </tr> <tr> <td>MC68EC30</td> <td>0</td> <td>1</td> <td>0</td> <td>0</td> <td>X</td> <td>X</td> <td>X</td> <td>X</td> </tr> <tr> <td>MC68040</td> <td>0</td> <td>1</td> <td>0</td> <td>1</td> <td>X</td> <td>X</td> <td>X</td> <td>X</td> </tr> <tr> <td>MC68040V</td> <td>0</td> <td>1</td> <td>1</td> <td>0</td> <td>X</td> <td>X</td> <td>X</td> <td>X</td> </tr> <tr> <td>MC68EC40</td> <td>0</td> <td>1</td> <td>1</td> <td>1</td> <td>X</td> <td>X</td> <td>X</td> <td>X</td> </tr> <tr> <td>486DX2-50</td> <td>1</td> <td>0</td> <td>0</td> <td>0</td> <td>0</td> <td>0</td> <td>0</td> <td>0</td> </tr> <tr> <td>486DX2-66</td> <td>1</td> <td>0</td> <td>0</td> <td>0</td> <td>0</td> <td>0</td> <td>0</td> <td>1</td> </tr> <tr> <td>486DX4</td> <td>1</td> <td>0</td> <td>0</td> <td>1</td> <td>X</td> <td>X</td> <td>X</td> <td>X</td> </tr> </tbody> </table>	Machine	Bit 3	Bit 2	Bit 1	Bit 0	FMX	0	0	0	0	C256U	0	0	0	1	Reserved	0	0	1	0	A2560 Dev	0	0	1	1	GEN X	0	1	0	0	C256U+	0	1	0	1	Reserved	0	1	1	0	Reserved	0	1	1	1	A2560X	1	0	0	0	A2560U	1	0	0	1	Reserved	1	0	1	0	A2560K	1	0	1	1		SPEED ID			CPU SPEED ID	2	1	0	14.318Mhz	0	0	0	20.000Mhz	0	0	1	25.000Mhz	0	1	0	33.000Mhz	0	1	1	40.000Mhz	1	0	0	50.000Mhz	1	0	1	66.000Mhz	1	1	0	80.000Mhz	1	1	1	CPU	CPU Model				Speed Grade				7	6	5	4	3	2	1	0	MC68SEC000	0	0	0	0	X	X	X	X	MC68020	0	0	0	1	X	X	X	X	MC68EC020	0	0	1	0	X	X	X	X	MC68030	0	0	1	1	X	X	X	X	MC68EC30	0	1	0	0	X	X	X	X	MC68040	0	1	0	1	X	X	X	X	MC68040V	0	1	1	0	X	X	X	X	MC68EC40	0	1	1	1	X	X	X	X	486DX2-50	1	0	0	0	0	0	0	0	486DX2-66	1	0	0	0	0	0	0	1	486DX4	1	0	0	1	X	X	X	X
Machine	Bit 3	Bit 2	Bit 1	Bit 0																																																																																																																																																																																																																													
FMX	0	0	0	0																																																																																																																																																																																																																													
C256U	0	0	0	1																																																																																																																																																																																																																													
Reserved	0	0	1	0																																																																																																																																																																																																																													
A2560 Dev	0	0	1	1																																																																																																																																																																																																																													
GEN X	0	1	0	0																																																																																																																																																																																																																													
C256U+	0	1	0	1																																																																																																																																																																																																																													
Reserved	0	1	1	0																																																																																																																																																																																																																													
Reserved	0	1	1	1																																																																																																																																																																																																																													
A2560X	1	0	0	0																																																																																																																																																																																																																													
A2560U	1	0	0	1																																																																																																																																																																																																																													
Reserved	1	0	1	0																																																																																																																																																																																																																													
A2560K	1	0	1	1																																																																																																																																																																																																																													
	SPEED ID																																																																																																																																																																																																																																
CPU SPEED ID	2	1	0																																																																																																																																																																																																																														
14.318Mhz	0	0	0																																																																																																																																																																																																																														
20.000Mhz	0	0	1																																																																																																																																																																																																																														
25.000Mhz	0	1	0																																																																																																																																																																																																																														
33.000Mhz	0	1	1																																																																																																																																																																																																																														
40.000Mhz	1	0	0																																																																																																																																																																																																																														
50.000Mhz	1	0	1																																																																																																																																																																																																																														
66.000Mhz	1	1	0																																																																																																																																																																																																																														
80.000Mhz	1	1	1																																																																																																																																																																																																																														
CPU	CPU Model				Speed Grade																																																																																																																																																																																																																												
	7	6	5	4	3	2	1	0																																																																																																																																																																																																																									
MC68SEC000	0	0	0	0	X	X	X	X																																																																																																																																																																																																																									
MC68020	0	0	0	1	X	X	X	X																																																																																																																																																																																																																									
MC68EC020	0	0	1	0	X	X	X	X																																																																																																																																																																																																																									
MC68030	0	0	1	1	X	X	X	X																																																																																																																																																																																																																									
MC68EC30	0	1	0	0	X	X	X	X																																																																																																																																																																																																																									
MC68040	0	1	0	1	X	X	X	X																																																																																																																																																																																																																									
MC68040V	0	1	1	0	X	X	X	X																																																																																																																																																																																																																									
MC68EC40	0	1	1	1	X	X	X	X																																																																																																																																																																																																																									
486DX2-50	1	0	0	0	0	0	0	0																																																																																																																																																																																																																									
486DX2-66	1	0	0	0	0	0	0	1																																																																																																																																																																																																																									
486DX4	1	0	0	1	X	X	X	X																																																																																																																																																																																																																									

A2560 FOENIX U – User Manual

0x000E		16	I/O	R/W	Reserved – Future Expansion
0x0010		16	I/O	R	Byte Order Hi Value @ Reset: 0x4567
0x0012		16	I/O	R	Byte Order Lo Value @ Reset: 0x0123
0x0014		16	I/O	R	Reserved Value @ Reset: 0x0000
0x0016		16	I/O	R	Reserved Value @ Reset: 0x0000
0x0018		16	I/O	R	Reserved Value @ Reset: 0x0000
0x001A		16	I/O	R	Reserved Value @ Reset: 0x0000
0x001C		16	I/O	R	Reserved Value @ Reset: 0x0000
0x001E		16	I/O	R	Reserved Value @ Reset: 0x0000

PRELIMINARY

2. Real Time Clock

(For Detailed information, please consult the BQ4802LY Datasheet)

Addy Start Offset	Addy End	Size	Type	R/W	Description																											
0x0080		8	I/O	R/W	RTC – Seconds Register <table border="1"> <thead> <tr> <th></th> <th>7</th> <th>6</th> <th>5</th> <th>4</th> <th>3</th> <th>2</th> <th>1</th> <th>0</th> </tr> </thead> <tbody> <tr> <td>Seconds (00-59)</td> <td>0</td> <td>T</td> <td>T</td> <td>T</td> <td>U</td> <td>U</td> <td>U</td> <td>U</td> </tr> </tbody> </table> <p>- T = Tens, U = Units</p>		7	6	5	4	3	2	1	0	Seconds (00-59)	0	T	T	T	U	U	U	U									
	7	6	5	4	3	2	1	0																								
Seconds (00-59)	0	T	T	T	U	U	U	U																								
0x0082		8	I/O	R/W	RTC – Seconds Alarm <table border="1"> <thead> <tr> <th></th> <th>7</th> <th>6</th> <th>5</th> <th>4</th> <th>3</th> <th>2</th> <th>1</th> <th>0</th> </tr> </thead> <tbody> <tr> <td>Seconds alarm</td> <td>ALM1</td> <td>ALM0</td> <td>T</td> <td>T</td> <td>U</td> <td>U</td> <td>U</td> <td>U</td> </tr> <tr> <td>Seconds alarm</td> <td>T</td> <td>T</td> <td>T</td> <td>T</td> <td>U</td> <td>U</td> <td>U</td> <td>U</td> </tr> </tbody> </table> <p>- T = Tens, U = Units</p>		7	6	5	4	3	2	1	0	Seconds alarm	ALM1	ALM0	T	T	U	U	U	U	Seconds alarm	T	T	T	T	U	U	U	U
	7	6	5	4	3	2	1	0																								
Seconds alarm	ALM1	ALM0	T	T	U	U	U	U																								
Seconds alarm	T	T	T	T	U	U	U	U																								
0x0084		8	I/O	R/W	RTC – Minutes Register <table border="1"> <thead> <tr> <th></th> <th>7</th> <th>6</th> <th>5</th> <th>4</th> <th>3</th> <th>2</th> <th>1</th> <th>0</th> </tr> </thead> <tbody> <tr> <td>Minutes (00-59)</td> <td>0</td> <td>T</td> <td>T</td> <td>T</td> <td>U</td> <td>U</td> <td>U</td> <td>U</td> </tr> </tbody> </table> <p>- T = Tens, U = Units</p>		7	6	5	4	3	2	1	0	Minutes (00-59)	0	T	T	T	U	U	U	U									
	7	6	5	4	3	2	1	0																								
Minutes (00-59)	0	T	T	T	U	U	U	U																								
0x0086		8	I/O	R/W	RTC – Minutes Alarm <table border="1"> <thead> <tr> <th></th> <th>7</th> <th>6</th> <th>5</th> <th>4</th> <th>3</th> <th>2</th> <th>1</th> <th>0</th> </tr> </thead> <tbody> <tr> <td>Minutes alarm</td> <td>ALM1</td> <td>ALM0</td> <td>T</td> <td>T</td> <td>U</td> <td>U</td> <td>U</td> <td>U</td> </tr> <tr> <td>Minutes alarm</td> <td>T</td> <td>T</td> <td>T</td> <td>T</td> <td>U</td> <td>U</td> <td>U</td> <td>U</td> </tr> </tbody> </table> <p>- T = Tens, U = Units</p>		7	6	5	4	3	2	1	0	Minutes alarm	ALM1	ALM0	T	T	U	U	U	U	Minutes alarm	T	T	T	T	U	U	U	U
	7	6	5	4	3	2	1	0																								
Minutes alarm	ALM1	ALM0	T	T	U	U	U	U																								
Minutes alarm	T	T	T	T	U	U	U	U																								
0x0088		8	I/O	R/W	RTC – Hours Register <table border="1"> <thead> <tr> <th></th> <th>7</th> <th>6</th> <th>5</th> <th>4</th> <th>3</th> <th>2</th> <th>1</th> <th>0</th> </tr> </thead> <tbody> <tr> <td>Hours (01-12AM) Hours (01-12PM)</td> <td>PM/AM</td> <td>0</td> <td>T</td> <td>T</td> <td>U</td> <td>U</td> <td>U</td> <td>U</td> </tr> <tr> <td>Hours (01-12AM) Hours (01-12PM)</td> <td>0</td> <td>T</td> <td>T</td> <td>T</td> <td>U</td> <td>U</td> <td>U</td> <td>U</td> </tr> </tbody> </table> <p>- T = Tens, U = Units</p>		7	6	5	4	3	2	1	0	Hours (01-12AM) Hours (01-12PM)	PM/AM	0	T	T	U	U	U	U	Hours (01-12AM) Hours (01-12PM)	0	T	T	T	U	U	U	U
	7	6	5	4	3	2	1	0																								
Hours (01-12AM) Hours (01-12PM)	PM/AM	0	T	T	U	U	U	U																								
Hours (01-12AM) Hours (01-12PM)	0	T	T	T	U	U	U	U																								
0x008A		8	I/O	R/W	RTC – Hours Alarm <table border="1"> <thead> <tr> <th></th> <th>7</th> <th>6</th> <th>5</th> <th>4</th> <th>3</th> <th>2</th> <th>1</th> <th>0</th> </tr> </thead> <tbody> <tr> <td>Hours (01-12AM) Hours (01-12PM)</td> <td>PM/AM ALM1</td> <td>ALM0</td> <td>T</td> <td>T</td> <td>U</td> <td>U</td> <td>U</td> <td>U</td> </tr> <tr> <td>Hours (01-12AM) Hours (01-12PM)</td> <td>0</td> <td>T</td> <td>T</td> <td>T</td> <td>U</td> <td>U</td> <td>U</td> <td>U</td> </tr> </tbody> </table> <p>- T = Tens, U = Units</p>		7	6	5	4	3	2	1	0	Hours (01-12AM) Hours (01-12PM)	PM/AM ALM1	ALM0	T	T	U	U	U	U	Hours (01-12AM) Hours (01-12PM)	0	T	T	T	U	U	U	U
	7	6	5	4	3	2	1	0																								
Hours (01-12AM) Hours (01-12PM)	PM/AM ALM1	ALM0	T	T	U	U	U	U																								
Hours (01-12AM) Hours (01-12PM)	0	T	T	T	U	U	U	U																								
0x008C		8	I/O	R/W	RTC – Day <table border="1"> <thead> <tr> <th></th> <th>7</th> <th>6</th> <th>5</th> <th>4</th> <th>3</th> <th>2</th> <th>1</th> <th>0</th> </tr> </thead> <tbody> <tr> <td>Day (01-31)</td> <td>0</td> <td>0</td> <td>T</td> <td>T</td> <td>U</td> <td>U</td> <td>U</td> <td>U</td> </tr> </tbody> </table> <p>- T = Tens, U = Units</p>		7	6	5	4	3	2	1	0	Day (01-31)	0	0	T	T	U	U	U	U									
	7	6	5	4	3	2	1	0																								
Day (01-31)	0	0	T	T	U	U	U	U																								
0x008E		8	I/O	R/W	RTC – Day Alarm <table border="1"> <thead> <tr> <th></th> <th>7</th> <th>6</th> <th>5</th> <th>4</th> <th>3</th> <th>2</th> <th>1</th> <th>0</th> </tr> </thead> <tbody> <tr> <td>Day (01-31)</td> <td>ALM1</td> <td>ALM0</td> <td>T</td> <td>T</td> <td>U</td> <td>U</td> <td>U</td> <td>U</td> </tr> <tr> <td>Day (01-31)</td> <td>0</td> <td>0</td> <td>T</td> <td>T</td> <td>U</td> <td>U</td> <td>U</td> <td>U</td> </tr> </tbody> </table> <p>- T = Tens, U = Units</p>		7	6	5	4	3	2	1	0	Day (01-31)	ALM1	ALM0	T	T	U	U	U	U	Day (01-31)	0	0	T	T	U	U	U	U
	7	6	5	4	3	2	1	0																								
Day (01-31)	ALM1	ALM0	T	T	U	U	U	U																								
Day (01-31)	0	0	T	T	U	U	U	U																								
0x0090		8	I/O	R/W	RTC – Day of Week <table border="1"> <thead> <tr> <th></th> <th>7</th> <th>6</th> <th>5</th> <th>4</th> <th>3</th> <th>2</th> <th>1</th> <th>0</th> </tr> </thead> <tbody> <tr> <td>Day of Week (01-07)</td> <td>0</td> <td>0</td> <td>0</td> <td>0</td> <td>0</td> <td>U</td> <td>U</td> <td>U</td> </tr> </tbody> </table> <p>- U = Units</p>		7	6	5	4	3	2	1	0	Day of Week (01-07)	0	0	0	0	0	U	U	U									
	7	6	5	4	3	2	1	0																								
Day of Week (01-07)	0	0	0	0	0	U	U	U																								
0x0092		8	I/O	R/W	RTC – Month <table border="1"> <thead> <tr> <th></th> <th>7</th> <th>6</th> <th>5</th> <th>4</th> <th>3</th> <th>2</th> <th>1</th> <th>0</th> </tr> </thead> <tbody> <tr> <td>Month (01-12)</td> <td>0</td> <td>0</td> <td>0</td> <td>T</td> <td>U</td> <td>U</td> <td>U</td> <td>U</td> </tr> </tbody> </table> <p>- T = Tens, U = Units</p>		7	6	5	4	3	2	1	0	Month (01-12)	0	0	0	T	U	U	U	U									
	7	6	5	4	3	2	1	0																								
Month (01-12)	0	0	0	T	U	U	U	U																								
0x0094		8	I/O	R/W	RTC – Year <table border="1"> <thead> <tr> <th></th> <th>7</th> <th>6</th> <th>5</th> <th>4</th> <th>3</th> <th>2</th> <th>1</th> <th>0</th> </tr> </thead> <tbody> <tr> <td>Years (99-00)</td> <td>T</td> <td>T</td> <td>T</td> <td>T</td> <td>U</td> <td>U</td> <td>U</td> <td>U</td> </tr> </tbody> </table> <p>- T = Tens, U = Units</p>		7	6	5	4	3	2	1	0	Years (99-00)	T	T	T	T	U	U	U	U									
	7	6	5	4	3	2	1	0																								
Years (99-00)	T	T	T	T	U	U	U	U																								
0x0096		8	I/O	R/W	RTC – Rates <table border="1"> <thead> <tr> <th></th> <th>7</th> <th>6</th> <th>5</th> <th>4</th> <th>3</th> <th>2</th> <th>1</th> <th>0</th> </tr> </thead> <tbody> <tr> <td></td> <td></td> <td></td> <td></td> <td></td> <td></td> <td></td> <td></td> <td></td> </tr> </tbody> </table>		7	6	5	4	3	2	1	0																		
	7	6	5	4	3	2	1	0																								

A2560 FOENIX U – User Manual

					<table border="1"> <tr> <td></td> <td>7</td> <td>6</td> <td>5</td> <td>4</td> <td>3</td> <td>2</td> <td>1</td> <td>0</td> </tr> <tr> <td>Rates</td> <td>0</td> <td>WD2</td> <td>WD1</td> <td>WD0</td> <td>RES3</td> <td>RES2</td> <td>RES1</td> <td>RES0</td> </tr> </table>		7	6	5	4	3	2	1	0	Rates	0	WD2	WD1	WD0	RES3	RES2	RES1	RES0									
	7	6	5	4	3	2	1	0																								
Rates	0	WD2	WD1	WD0	RES3	RES2	RES1	RES0																								
0x0098		8	I/O	R/W	RTC – Enables <table border="1"> <tr> <td></td> <td>7</td> <td>6</td> <td>5</td> <td>4</td> <td>3</td> <td>2</td> <td>1</td> <td>0</td> </tr> <tr> <td>Enables</td> <td>0</td> <td>0</td> <td>0</td> <td>0</td> <td>AIE</td> <td>PIE</td> <td>PWRIE</td> <td>ABE</td> </tr> </table>		7	6	5	4	3	2	1	0	Enables	0	0	0	0	AIE	PIE	PWRIE	ABE									
	7	6	5	4	3	2	1	0																								
Enables	0	0	0	0	AIE	PIE	PWRIE	ABE																								
0x009A		8	I/O	R/W	RTC – Flags <table border="1"> <tr> <td></td> <td>7</td> <td>6</td> <td>5</td> <td>4</td> <td>3</td> <td>2</td> <td>1</td> <td>0</td> </tr> <tr> <td>Flags</td> <td>0</td> <td>0</td> <td>0</td> <td>0</td> <td>AF</td> <td>PF</td> <td>PWRF</td> <td>BVF</td> </tr> </table>		7	6	5	4	3	2	1	0	Flags	0	0	0	0	AF	PF	PWRF	BVF									
	7	6	5	4	3	2	1	0																								
Flags	0	0	0	0	AF	PF	PWRF	BVF																								
0x009C		8	I/O	R/W	RTC – Control <table border="1"> <tr> <td></td> <td>7</td> <td>6</td> <td>5</td> <td>4</td> <td>3</td> <td>2</td> <td>1</td> <td>0</td> </tr> <tr> <td>Control</td> <td>0</td> <td>0</td> <td>0</td> <td>0</td> <td>UTI</td> <td>STOPn</td> <td>24/12</td> <td>DSE</td> </tr> </table>		7	6	5	4	3	2	1	0	Control	0	0	0	0	UTI	STOPn	24/12	DSE									
	7	6	5	4	3	2	1	0																								
Control	0	0	0	0	UTI	STOPn	24/12	DSE																								
0x009E		8	I/O	R/W	RTC – Century <table border="1"> <tr> <td></td> <td colspan="4">10 Year Digit</td> <td colspan="4">1 Year Digit</td> </tr> <tr> <td></td> <td>7</td> <td>6</td> <td>5</td> <td>4</td> <td>3</td> <td>2</td> <td>1</td> <td>0</td> </tr> <tr> <td>Century (99-00)</td> <td>T</td> <td>T</td> <td>T</td> <td>T</td> <td>U</td> <td>U</td> <td>U</td> <td>U</td> </tr> </table> <p>T = Tens, U = Units</p>		10 Year Digit				1 Year Digit					7	6	5	4	3	2	1	0	Century (99-00)	T	T	T	T	U	U	U	U
	10 Year Digit				1 Year Digit																											
	7	6	5	4	3	2	1	0																								
Century (99-00)	T	T	T	T	U	U	U	U																								

PRELIMINARY

3. Interrupt Controller Registers

Addy Start Offset	Addy End	Size	Type	R/W	Description																																																																																																																																																																																																																																																																																																	
0x0100		16	I/O	R/W	Interrupt Pending Register Group 0 (VICKY)																																																																																																																																																																																																																																																																																																	
					<table border="1"> <thead> <tr> <th>Interrupt Source</th> <th>15</th> <th>14</th> <th>13</th> <th>12</th> <th>11</th> <th>10</th> <th>9</th> <th>8</th> <th>7</th> <th>6</th> <th>5</th> <th>4</th> <th>3</th> <th>2</th> <th>1</th> <th>0</th> </tr> </thead> <tbody> <tr> <td>VICKY INT0 (SOF)</td> <td>0</td> <td>0</td> <td>0</td> <td>0</td> <td>0</td> <td>0</td> <td>0</td> <td>0</td> <td>0</td> <td>0</td> <td>0</td> <td>0</td> <td>0</td> <td>0</td> <td>0</td> <td>1</td> </tr> <tr> <td>VICKY INT1 (SOL)</td> <td>0</td> <td>0</td> <td>0</td> <td>0</td> <td>0</td> <td>0</td> <td>0</td> <td>0</td> <td>0</td> <td>0</td> <td>0</td> <td>0</td> <td>0</td> <td>0</td> <td>1</td> <td>0</td> </tr> <tr> <td>VICKY INT2 (Sprite Collision)</td> <td>0</td> <td>0</td> <td>0</td> <td>0</td> <td>0</td> <td>0</td> <td>0</td> <td>0</td> <td>0</td> <td>0</td> <td>0</td> <td>0</td> <td>0</td> <td>1</td> <td>0</td> <td>0</td> </tr> <tr> <td>VICKY INT3 (Bitmap Collision)</td> <td>0</td> <td>0</td> <td>0</td> <td>0</td> <td>0</td> <td>0</td> <td>0</td> <td>0</td> <td>0</td> <td>0</td> <td>0</td> <td>0</td> <td>1</td> <td>0</td> <td>0</td> <td>0</td> </tr> <tr> <td>VICKY INT4 (VDMA Interrupt)</td> <td>0</td> <td>0</td> <td>0</td> <td>0</td> <td>0</td> <td>0</td> <td>0</td> <td>0</td> <td>0</td> <td>0</td> <td>0</td> <td>1</td> <td>0</td> <td>0</td> <td>0</td> <td>0</td> </tr> <tr> <td>VICKY INT5 (Tile Collision)</td> <td>0</td> <td>0</td> <td>0</td> <td>0</td> <td>0</td> <td>0</td> <td>0</td> <td>0</td> <td>0</td> <td>0</td> <td>1</td> <td>0</td> <td>0</td> <td>0</td> <td>0</td> <td>0</td> </tr> <tr> <td>Reserved</td> <td>0</td> <td>0</td> <td>0</td> <td>0</td> <td>0</td> <td>0</td> <td>0</td> <td>0</td> <td>0</td> <td>1</td> <td>0</td> <td>0</td> <td>0</td> <td>0</td> <td>0</td> <td>0</td> </tr> <tr> <td>VICKY Hot-Plug</td> <td>0</td> <td>0</td> <td>0</td> <td>0</td> <td>0</td> <td>0</td> <td>0</td> <td>0</td> <td>1</td> <td>0</td> <td>0</td> <td>0</td> <td>0</td> <td>0</td> <td>0</td> <td>0</td> </tr> <tr> <td>Reserved</td> <td>0</td> <td>0</td> <td>0</td> <td>0</td> <td>0</td> <td>0</td> <td>0</td> <td>0</td> <td>0</td> <td>0</td> <td>0</td> <td>0</td> <td>0</td> <td>0</td> <td>0</td> <td>0</td> </tr> <tr> <td>Reserved</td> <td>0</td> <td>0</td> <td>0</td> <td>0</td> <td>0</td> <td>0</td> <td>0</td> <td>0</td> <td>0</td> <td>0</td> <td>0</td> <td>0</td> <td>0</td> <td>0</td> <td>0</td> <td>0</td> </tr> <tr> <td>Reserved</td> <td>0</td> <td>0</td> <td>0</td> <td>0</td> <td>0</td> <td>0</td> <td>0</td> <td>0</td> <td>0</td> <td>0</td> <td>0</td> <td>0</td> <td>0</td> <td>0</td> <td>0</td> <td>0</td> </tr> <tr> <td>Reserved</td> <td>0</td> <td>0</td> <td>0</td> <td>0</td> <td>0</td> <td>0</td> <td>0</td> <td>0</td> <td>0</td> <td>0</td> <td>0</td> <td>0</td> <td>0</td> <td>0</td> <td>0</td> <td>0</td> </tr> <tr> <td>Reserved</td> <td>0</td> <td>0</td> <td>0</td> <td>0</td> <td>0</td> <td>0</td> <td>0</td> <td>0</td> <td>0</td> <td>0</td> <td>0</td> <td>0</td> <td>0</td> <td>0</td> <td>0</td> <td>0</td> </tr> <tr> <td>Reserved</td> <td>0</td> <td>0</td> <td>0</td> <td>0</td> <td>0</td> <td>0</td> <td>0</td> <td>0</td> <td>0</td> <td>0</td> <td>0</td> <td>0</td> <td>0</td> <td>0</td> <td>0</td> <td>0</td> </tr> <tr> <td>Reserved</td> <td>0</td> <td>0</td> <td>0</td> <td>0</td> <td>0</td> <td>0</td> <td>0</td> <td>0</td> <td>0</td> <td>0</td> <td>0</td> <td>0</td> <td>0</td> <td>0</td> <td>0</td> <td>0</td> </tr> <tr> <td>Reserved</td> <td>0</td> <td>0</td> <td>0</td> <td>0</td> <td>0</td> <td>0</td> <td>0</td> <td>0</td> <td>0</td> <td>0</td> <td>0</td> <td>0</td> <td>0</td> <td>0</td> <td>0</td> <td>0</td> </tr> </tbody> </table>	Interrupt Source	15	14	13	12	11	10	9	8	7	6	5	4	3	2	1	0	VICKY INT0 (SOF)	0	0	0	0	0	0	0	0	0	0	0	0	0	0	0	1	VICKY INT1 (SOL)	0	0	0	0	0	0	0	0	0	0	0	0	0	0	1	0	VICKY INT2 (Sprite Collision)	0	0	0	0	0	0	0	0	0	0	0	0	0	1	0	0	VICKY INT3 (Bitmap Collision)	0	0	0	0	0	0	0	0	0	0	0	0	1	0	0	0	VICKY INT4 (VDMA Interrupt)	0	0	0	0	0	0	0	0	0	0	0	1	0	0	0	0	VICKY INT5 (Tile Collision)	0	0	0	0	0	0	0	0	0	0	1	0	0	0	0	0	Reserved	0	0	0	0	0	0	0	0	0	1	0	0	0	0	0	0	VICKY Hot-Plug	0	0	0	0	0	0	0	0	1	0	0	0	0	0	0	0	Reserved	0	0	0	0	0	0	0	0	0	0	0	0	0	0	0	0	Reserved	0	0	0	0	0	0	0	0	0	0	0	0	0	0	0	0	Reserved	0	0	0	0	0	0	0	0	0	0	0	0	0	0	0	0	Reserved	0	0	0	0	0	0	0	0	0	0	0	0	0	0	0	0	Reserved	0	0	0	0	0	0	0	0	0	0	0	0	0	0	0	0	Reserved	0	0	0	0	0	0	0	0	0	0	0	0	0	0	0	0	Reserved	0	0	0	0	0	0	0	0	0	0	0	0	0	0	0	0	Reserved	0	0	0	0	0	0	0	0	0	0	0	0	0	0	0	0
					Interrupt Source	15	14	13	12	11	10	9	8	7	6	5	4	3	2	1	0																																																																																																																																																																																																																																																																																	
					VICKY INT0 (SOF)	0	0	0	0	0	0	0	0	0	0	0	0	0	0	0	1																																																																																																																																																																																																																																																																																	
					VICKY INT1 (SOL)	0	0	0	0	0	0	0	0	0	0	0	0	0	0	1	0																																																																																																																																																																																																																																																																																	
					VICKY INT2 (Sprite Collision)	0	0	0	0	0	0	0	0	0	0	0	0	0	1	0	0																																																																																																																																																																																																																																																																																	
					VICKY INT3 (Bitmap Collision)	0	0	0	0	0	0	0	0	0	0	0	0	1	0	0	0																																																																																																																																																																																																																																																																																	
					VICKY INT4 (VDMA Interrupt)	0	0	0	0	0	0	0	0	0	0	0	1	0	0	0	0																																																																																																																																																																																																																																																																																	
					VICKY INT5 (Tile Collision)	0	0	0	0	0	0	0	0	0	0	1	0	0	0	0	0																																																																																																																																																																																																																																																																																	
					Reserved	0	0	0	0	0	0	0	0	0	1	0	0	0	0	0	0																																																																																																																																																																																																																																																																																	
					VICKY Hot-Plug	0	0	0	0	0	0	0	0	1	0	0	0	0	0	0	0																																																																																																																																																																																																																																																																																	
					Reserved	0	0	0	0	0	0	0	0	0	0	0	0	0	0	0	0																																																																																																																																																																																																																																																																																	
					Reserved	0	0	0	0	0	0	0	0	0	0	0	0	0	0	0	0																																																																																																																																																																																																																																																																																	
					Reserved	0	0	0	0	0	0	0	0	0	0	0	0	0	0	0	0																																																																																																																																																																																																																																																																																	
					Reserved	0	0	0	0	0	0	0	0	0	0	0	0	0	0	0	0																																																																																																																																																																																																																																																																																	
					Reserved	0	0	0	0	0	0	0	0	0	0	0	0	0	0	0	0																																																																																																																																																																																																																																																																																	
					Reserved	0	0	0	0	0	0	0	0	0	0	0	0	0	0	0	0																																																																																																																																																																																																																																																																																	
					Reserved	0	0	0	0	0	0	0	0	0	0	0	0	0	0	0	0																																																																																																																																																																																																																																																																																	
					Reserved	0	0	0	0	0	0	0	0	0	0	0	0	0	0	0	0																																																																																																																																																																																																																																																																																	
					Value @ Reset: 0x0000																																																																																																																																																																																																																																																																																																	
					0x0102		16	I/O	R/W	Interrupt Pending Register Group 1 (GAVIN)																																																																																																																																																																																																																																																																																												
<table border="1"> <thead> <tr> <th>Interrupt Source</th> <th>15</th> <th>14</th> <th>13</th> <th>12</th> <th>11</th> <th>10</th> <th>9</th> <th>8</th> <th>7</th> <th>6</th> <th>5</th> <th>4</th> <th>3</th> <th>2</th> <th>1</th> <th>0</th> </tr> </thead> <tbody> <tr> <td>PS2 Keyboard</td> <td>0</td> <td>0</td> <td>0</td> <td>0</td> <td>0</td> <td>0</td> <td>0</td> <td>0</td> <td>0</td> <td>0</td> <td>0</td> <td>0</td> <td>0</td> <td>0</td> <td>0</td> <td>1</td> </tr> <tr> <td>Reserved</td> <td>0</td> <td>0</td> <td>0</td> <td>0</td> <td>0</td> <td>0</td> <td>0</td> <td>0</td> <td>0</td> <td>0</td> <td>0</td> <td>0</td> <td>0</td> <td>0</td> <td>0</td> <td>0</td> </tr> <tr> <td>PS2 Mouse</td> <td>0</td> <td>0</td> <td>0</td> <td>0</td> <td>0</td> <td>0</td> <td>0</td> <td>0</td> <td>0</td> <td>0</td> <td>0</td> <td>0</td> <td>0</td> <td>1</td> <td>0</td> <td>0</td> </tr> <tr> <td>COM1</td> <td>0</td> <td>0</td> <td>0</td> <td>0</td> <td>0</td> <td>0</td> <td>0</td> <td>0</td> <td>0</td> <td>0</td> <td>0</td> <td>0</td> <td>1</td> <td>0</td> <td>0</td> <td>0</td> </tr> <tr> <td>Reserved</td> <td>0</td> <td>0</td> <td>0</td> <td>0</td> <td>0</td> <td>0</td> <td>0</td> <td>0</td> <td>0</td> <td>0</td> <td>0</td> <td>0</td> <td>0</td> <td>0</td> <td>0</td> <td>0</td> </tr> <tr> <td>Reserved</td> <td>0</td> <td>0</td> <td>0</td> <td>0</td> <td>0</td> <td>0</td> <td>0</td> <td>0</td> <td>0</td> <td>0</td> <td>0</td> <td>0</td> <td>0</td> <td>0</td> <td>0</td> <td>0</td> </tr> <tr> <td>Reserved</td> <td>0</td> <td>0</td> <td>0</td> <td>0</td> <td>0</td> <td>0</td> <td>0</td> <td>0</td> <td>0</td> <td>0</td> <td>0</td> <td>0</td> <td>0</td> <td>0</td> <td>0</td> <td>0</td> </tr> <tr> <td>Reserved</td> <td>0</td> <td>0</td> <td>0</td> <td>0</td> <td>0</td> <td>0</td> <td>0</td> <td>0</td> <td>0</td> <td>0</td> <td>0</td> <td>0</td> <td>0</td> <td>0</td> <td>0</td> <td>0</td> </tr> <tr> <td>Timer 0 (CPU Clock)</td> <td>0</td> <td>0</td> <td>0</td> <td>0</td> <td>0</td> <td>0</td> <td>0</td> <td>1</td> <td>0</td> <td>0</td> <td>0</td> <td>0</td> <td>0</td> <td>0</td> <td>0</td> <td>0</td> </tr> <tr> <td>Timer 1 (CPU Clock)</td> <td>0</td> <td>0</td> <td>0</td> <td>0</td> <td>0</td> <td>0</td> <td>0</td> <td>1</td> <td>0</td> <td>0</td> <td>0</td> <td>0</td> <td>0</td> <td>0</td> <td>0</td> <td>0</td> </tr> <tr> <td>Timer 2 (CPU Clock)</td> <td>0</td> <td>0</td> <td>0</td> <td>0</td> <td>0</td> <td>0</td> <td>1</td> <td>0</td> <td>0</td> <td>0</td> <td>0</td> <td>0</td> <td>0</td> <td>0</td> <td>0</td> <td>0</td> </tr> <tr> <td>Timer 3 (SOF Clock)</td> <td>0</td> <td>0</td> <td>0</td> <td>0</td> <td>1</td> <td>0</td> <td>0</td> <td>0</td> <td>0</td> <td>0</td> <td>0</td> <td>0</td> <td>0</td> <td>0</td> <td>0</td> <td>0</td> </tr> <tr> <td>Reserved</td> <td>0</td> <td>0</td> <td>0</td> <td>0</td> <td>0</td> <td>0</td> <td>0</td> <td>0</td> <td>0</td> <td>0</td> <td>0</td> <td>0</td> <td>0</td> <td>0</td> <td>0</td> <td>0</td> </tr> <tr> <td>Reserved</td> <td>0</td> <td>0</td> <td>0</td> <td>0</td> <td>0</td> <td>0</td> <td>0</td> <td>0</td> <td>0</td> <td>0</td> <td>0</td> <td>0</td> <td>0</td> <td>0</td> <td>0</td> <td>0</td> </tr> <tr> <td>Reserved</td> <td>0</td> <td>0</td> <td>0</td> <td>0</td> <td>0</td> <td>0</td> <td>0</td> <td>0</td> <td>0</td> <td>0</td> <td>0</td> <td>0</td> <td>0</td> <td>0</td> <td>0</td> <td>0</td> </tr> <tr> <td>RTC</td> <td>1</td> <td>0</td> <td>0</td> <td>0</td> <td>0</td> <td>0</td> <td>0</td> <td>0</td> <td>0</td> <td>0</td> <td>0</td> <td>0</td> <td>0</td> <td>0</td> <td>0</td> <td>0</td> </tr> </tbody> </table>	Interrupt Source	15	14	13						12	11	10	9	8	7	6	5	4	3	2	1	0	PS2 Keyboard	0	0	0	0	0	0	0	0	0	0	0	0	0	0	0	1	Reserved	0	0	0	0	0	0	0	0	0	0	0	0	0	0	0	0	PS2 Mouse	0	0	0	0	0	0	0	0	0	0	0	0	0	1	0	0	COM1	0	0	0	0	0	0	0	0	0	0	0	0	1	0	0	0	Reserved	0	0	0	0	0	0	0	0	0	0	0	0	0	0	0	0	Reserved	0	0	0	0	0	0	0	0	0	0	0	0	0	0	0	0	Reserved	0	0	0	0	0	0	0	0	0	0	0	0	0	0	0	0	Reserved	0	0	0	0	0	0	0	0	0	0	0	0	0	0	0	0	Timer 0 (CPU Clock)	0	0	0	0	0	0	0	1	0	0	0	0	0	0	0	0	Timer 1 (CPU Clock)	0	0	0	0	0	0	0	1	0	0	0	0	0	0	0	0	Timer 2 (CPU Clock)	0	0	0	0	0	0	1	0	0	0	0	0	0	0	0	0	Timer 3 (SOF Clock)	0	0	0	0	1	0	0	0	0	0	0	0	0	0	0	0	Reserved	0	0	0	0	0	0	0	0	0	0	0	0	0	0	0	0	Reserved	0	0	0	0	0	0	0	0	0	0	0	0	0	0	0	0	Reserved	0	0	0	0	0	0	0	0	0	0	0	0	0	0	0	0	RTC	1	0	0	0	0	0	0	0	0	0	0	0	0	0	0	0
Interrupt Source	15	14	13	12						11	10	9	8	7	6	5	4	3	2	1	0																																																																																																																																																																																																																																																																																	
PS2 Keyboard	0	0	0	0						0	0	0	0	0	0	0	0	0	0	0	1																																																																																																																																																																																																																																																																																	
Reserved	0	0	0	0						0	0	0	0	0	0	0	0	0	0	0	0																																																																																																																																																																																																																																																																																	
PS2 Mouse	0	0	0	0						0	0	0	0	0	0	0	0	0	1	0	0																																																																																																																																																																																																																																																																																	
COM1	0	0	0	0						0	0	0	0	0	0	0	0	1	0	0	0																																																																																																																																																																																																																																																																																	
Reserved	0	0	0	0						0	0	0	0	0	0	0	0	0	0	0	0																																																																																																																																																																																																																																																																																	
Reserved	0	0	0	0						0	0	0	0	0	0	0	0	0	0	0	0																																																																																																																																																																																																																																																																																	
Reserved	0	0	0	0						0	0	0	0	0	0	0	0	0	0	0	0																																																																																																																																																																																																																																																																																	
Reserved	0	0	0	0						0	0	0	0	0	0	0	0	0	0	0	0																																																																																																																																																																																																																																																																																	
Timer 0 (CPU Clock)	0	0	0	0						0	0	0	1	0	0	0	0	0	0	0	0																																																																																																																																																																																																																																																																																	
Timer 1 (CPU Clock)	0	0	0	0						0	0	0	1	0	0	0	0	0	0	0	0																																																																																																																																																																																																																																																																																	
Timer 2 (CPU Clock)	0	0	0	0						0	0	1	0	0	0	0	0	0	0	0	0																																																																																																																																																																																																																																																																																	
Timer 3 (SOF Clock)	0	0	0	0						1	0	0	0	0	0	0	0	0	0	0	0																																																																																																																																																																																																																																																																																	
Reserved	0	0	0	0						0	0	0	0	0	0	0	0	0	0	0	0																																																																																																																																																																																																																																																																																	
Reserved	0	0	0	0						0	0	0	0	0	0	0	0	0	0	0	0																																																																																																																																																																																																																																																																																	
Reserved	0	0	0	0						0	0	0	0	0	0	0	0	0	0	0	0																																																																																																																																																																																																																																																																																	
RTC	1	0	0	0						0	0	0	0	0	0	0	0	0	0	0	0																																																																																																																																																																																																																																																																																	
Value @ Reset: 0x0000																																																																																																																																																																																																																																																																																																						
0x0104		16	I/O	R/W						Interrupt Pending Register Group 2 (BEATRIX)																																																																																																																																																																																																																																																																																												
					<table border="1"> <thead> <tr> <th>Interrupt Source</th> <th>15</th> <th>14</th> <th>13</th> <th>12</th> <th>11</th> <th>10</th> <th>9</th> <th>8</th> <th>7</th> <th>6</th> <th>5</th> <th>4</th> <th>3</th> <th>2</th> <th>1</th> <th>0</th> </tr> </thead> <tbody> <tr> <td>IDE</td> <td>0</td> <td>0</td> <td>0</td> <td>0</td> <td>0</td> <td>0</td> <td>0</td> <td>0</td> <td>0</td> <td>0</td> <td>0</td> <td>0</td> <td>0</td> <td>0</td> <td>0</td> <td>1</td> </tr> <tr> <td>SDCard Insert</td> <td>0</td> <td>0</td> <td>0</td> <td>0</td> <td>0</td> <td>0</td> <td>0</td> <td>0</td> <td>0</td> <td>0</td> <td>0</td> <td>0</td> <td>0</td> <td>0</td> <td>0</td> <td>1</td> </tr> <tr> <td>Reserved</td> <td>0</td> <td>0</td> <td>0</td> <td>0</td> <td>0</td> <td>0</td> <td>0</td> <td>0</td> <td>0</td> <td>0</td> <td>0</td> <td>0</td> <td>0</td> <td>0</td> <td>0</td> <td>0</td> </tr> <tr> <td>Reserved</td> <td>0</td> <td>0</td> <td>0</td> <td>0</td> <td>0</td> <td>0</td> <td>0</td> <td>0</td> <td>0</td> <td>0</td> <td>0</td> <td>0</td> <td>0</td> <td>0</td> <td>0</td> <td>0</td> </tr> <tr> <td>Reserved</td> <td>0</td> <td>0</td> <td>0</td> <td>0</td> <td>0</td> <td>0</td> <td>0</td> <td>0</td> <td>0</td> <td>0</td> <td>0</td> <td>0</td> <td>0</td> <td>0</td> <td>0</td> <td>0</td> </tr> <tr> <td>OPL3</td> <td>0</td> <td>0</td> <td>0</td> <td>0</td> <td>0</td> <td>0</td> <td>0</td> <td>0</td> <td>0</td> <td>0</td> <td>0</td> <td>1</td> <td>0</td> <td>0</td> <td>0</td> <td>0</td> </tr> <tr> <td>Reserved</td> <td>0</td> <td>0</td> <td>0</td> <td>0</td> <td>0</td> <td>0</td> <td>0</td> <td>0</td> <td>0</td> <td>0</td> <td>0</td> <td>0</td> <td>0</td> <td>0</td> <td>0</td> <td>0</td> </tr> <tr> <td>Reserved</td> <td>0</td> <td>0</td> <td>0</td> <td>0</td> <td>0</td> <td>0</td> <td>0</td> <td>0</td> <td>0</td> <td>0</td> <td>0</td> <td>0</td> <td>0</td> <td>0</td> <td>0</td> <td>0</td> </tr> <tr> <td>BTX INT0 (TBD)</td> <td>0</td> <td>0</td> <td>0</td> <td>0</td> <td>0</td> <td>0</td> <td>0</td> <td>0</td> <td>0</td> <td>0</td> <td>0</td> <td>0</td> <td>0</td> <td>0</td> <td>0</td> <td>0</td> </tr> <tr> <td>BTX INT1 (TBD)</td> <td>0</td> <td>0</td> <td>0</td> <td>0</td> <td>0</td> <td>0</td> <td>0</td> <td>0</td> <td>0</td> <td>0</td> <td>0</td> <td>0</td> <td>0</td> <td>0</td> <td>0</td> <td>0</td> </tr> <tr> <td>BTX INT2 (TBD)</td> <td>0</td> <td>0</td> <td>0</td> <td>0</td> <td>0</td> <td>0</td> <td>0</td> <td>0</td> <td>0</td> <td>0</td> <td>0</td> <td>0</td> <td>0</td> <td>0</td> <td>0</td> <td>0</td> </tr> <tr> <td>BTX INT3 (TBD)</td> <td>0</td> <td>0</td> <td>0</td> <td>0</td> <td>0</td> <td>0</td> <td>0</td> <td>0</td> <td>0</td> <td>0</td> <td>0</td> <td>0</td> <td>0</td> <td>0</td> <td>0</td> <td>0</td> </tr> <tr> <td>Reserved</td> <td>0</td> <td>0</td> <td>0</td> <td>0</td> <td>0</td> <td>0</td> <td>0</td> <td>0</td> <td>0</td> <td>0</td> <td>0</td> <td>0</td> <td>0</td> <td>0</td> <td>0</td> <td>0</td> </tr> <tr> <td>Reserved</td> <td>0</td> <td>0</td> <td>0</td> <td>0</td> <td>0</td> <td>0</td> <td>0</td> <td>0</td> <td>0</td> <td>0</td> <td>0</td> <td>0</td> <td>0</td> <td>0</td> <td>0</td> <td>0</td> </tr> <tr> <td>Reserved</td> <td>0</td> <td>0</td> <td>0</td> <td>0</td> <td>0</td> <td>0</td> <td>0</td> <td>0</td> <td>0</td> <td>0</td> <td>0</td> <td>0</td> <td>0</td> <td>0</td> <td>0</td> <td>0</td> </tr> <tr> <td>DAC0 Playback</td> <td>1</td> <td>0</td> <td>0</td> <td>0</td> <td>0</td> <td>0</td> <td>0</td> <td>0</td> <td>0</td> <td>0</td> <td>0</td> <td>0</td> <td>0</td> <td>0</td> <td>0</td> <td>0</td> </tr> </tbody> </table>	Interrupt Source	15	14	13	12	11	10	9	8	7	6	5	4	3	2	1	0	IDE	0	0	0	0	0	0	0	0	0	0	0	0	0	0	0	1	SDCard Insert	0	0	0	0	0	0	0	0	0	0	0	0	0	0	0	1	Reserved	0	0	0	0	0	0	0	0	0	0	0	0	0	0	0	0	Reserved	0	0	0	0	0	0	0	0	0	0	0	0	0	0	0	0	Reserved	0	0	0	0	0	0	0	0	0	0	0	0	0	0	0	0	OPL3	0	0	0	0	0	0	0	0	0	0	0	1	0	0	0	0	Reserved	0	0	0	0	0	0	0	0	0	0	0	0	0	0	0	0	Reserved	0	0	0	0	0	0	0	0	0	0	0	0	0	0	0	0	BTX INT0 (TBD)	0	0	0	0	0	0	0	0	0	0	0	0	0	0	0	0	BTX INT1 (TBD)	0	0	0	0	0	0	0	0	0	0	0	0	0	0	0	0	BTX INT2 (TBD)	0	0	0	0	0	0	0	0	0	0	0	0	0	0	0	0	BTX INT3 (TBD)	0	0	0	0	0	0	0	0	0	0	0	0	0	0	0	0	Reserved	0	0	0	0	0	0	0	0	0	0	0	0	0	0	0	0	Reserved	0	0	0	0	0	0	0	0	0	0	0	0	0	0	0	0	Reserved	0	0	0	0	0	0	0	0	0	0	0	0	0	0	0	0	DAC0 Playback	1	0	0	0	0	0	0	0	0	0	0	0	0	0	0	0
					Interrupt Source	15	14	13	12	11	10	9	8	7	6	5	4	3	2	1	0																																																																																																																																																																																																																																																																																	
					IDE	0	0	0	0	0	0	0	0	0	0	0	0	0	0	0	1																																																																																																																																																																																																																																																																																	
					SDCard Insert	0	0	0	0	0	0	0	0	0	0	0	0	0	0	0	1																																																																																																																																																																																																																																																																																	
					Reserved	0	0	0	0	0	0	0	0	0	0	0	0	0	0	0	0																																																																																																																																																																																																																																																																																	
					Reserved	0	0	0	0	0	0	0	0	0	0	0	0	0	0	0	0																																																																																																																																																																																																																																																																																	
					Reserved	0	0	0	0	0	0	0	0	0	0	0	0	0	0	0	0																																																																																																																																																																																																																																																																																	
					OPL3	0	0	0	0	0	0	0	0	0	0	0	1	0	0	0	0																																																																																																																																																																																																																																																																																	
					Reserved	0	0	0	0	0	0	0	0	0	0	0	0	0	0	0	0																																																																																																																																																																																																																																																																																	
					Reserved	0	0	0	0	0	0	0	0	0	0	0	0	0	0	0	0																																																																																																																																																																																																																																																																																	
					BTX INT0 (TBD)	0	0	0	0	0	0	0	0	0	0	0	0	0	0	0	0																																																																																																																																																																																																																																																																																	
					BTX INT1 (TBD)	0	0	0	0	0	0	0	0	0	0	0	0	0	0	0	0																																																																																																																																																																																																																																																																																	
					BTX INT2 (TBD)	0	0	0	0	0	0	0	0	0	0	0	0	0	0	0	0																																																																																																																																																																																																																																																																																	
					BTX INT3 (TBD)	0	0	0	0	0	0	0	0	0	0	0	0	0	0	0	0																																																																																																																																																																																																																																																																																	
					Reserved	0	0	0	0	0	0	0	0	0	0	0	0	0	0	0	0																																																																																																																																																																																																																																																																																	
					Reserved	0	0	0	0	0	0	0	0	0	0	0	0	0	0	0	0																																																																																																																																																																																																																																																																																	
					Reserved	0	0	0	0	0	0	0	0	0	0	0	0	0	0	0	0																																																																																																																																																																																																																																																																																	
					DAC0 Playback	1	0	0	0	0	0	0	0	0	0	0	0	0	0	0	0																																																																																																																																																																																																																																																																																	
					Value @ Reset: 0x0000																																																																																																																																																																																																																																																																																																	
					0x0106		16	I/O	R/W	Reserved																																																																																																																																																																																																																																																																																												

A2560 FOENIX U – User Manual

0x0108		16	I/O	R/W	Polarity Register Group 0 (Not in Use) Value @ Reset: 0x0000
0x010A		16	I/O	R/W	Polarity Register Group 1 (Not in Use) Value @ Reset: 0x0000
0x010C		16	I/O	R/W	Polarity Register Group 2 (Not in Use) Value @ Reset: 0x0000
0x010E		16	I/O	R/W	Reserved
0x0110		16	I/O	R/W	EDGE Register Group 0 (Not in Use) Value @ Reset: 0xFFFF
0x0112		16	I/O	R/W	EDGE Register Group 1 (Not in Use) Value @ Reset: 0xFFFF
0x0114		16	I/O	R/W	EDGE Register Group 2 (Not in Use) Value @ Reset: 0xFFFF
0x0116		16	I/O	R/W	Reserved
0x0118		16	I/O	R/W	MASK Register Group 0 Value @ Reset: 0xFFFF
0x011A		16	I/O	R/W	MASK Register Group 1 Value @ Reset: 0xFFFF
0x011C		16	I/O	R/W	MASK Register Group 2 Value @ Reset: 0xFFFF
0x011E		16	I/O	R/W	Reserved

Priority Level & Grouping

IPL	Priority	Group Definition	VECTORS
111	No Interrupt		
110	Lowest Priority	BEATRIX – DAC	0x58..0x5F – INT Group 2B
101		BEATRIX – IDE/SD, Yamaha	0x50..0x57 – INT Group 2A
100		GAVIN - Timer Group	0x48..0x4F – INT Group 1B
011		GAVIN - SuperIO Group (KB, Mouse, Etc.)	0x40..0x47 – INT Group 1A
010		VICKY Interrupts Auto-Vector (SOF, SOL, Collision, Etc.)	0x1A – INT Group 0A
001	Highest Priority	Not Used in A2560U.	
000	NMI	Not Used	

4. Timer Controllers Registers

Addy Start Offset	Addy End	Size	Type	R/W	Description
0x0200		32	I/O	R/W	<p>Control Register 0 Value @ Reset: 0x0000_0000</p>
0x0204		32	I/O	R/W	<p>Control Register 1 Value @ Reset: 0x0000_0000</p>
0x0208		32	I/O	R/W	Timer 0 Value (@ CPU Clock)
0x020C		32	I/O	R/W	Timer 0 Compare
0x0210		32	I/O	R/W	Timer 1 Value (@ CPU Clock)
0x0214		32	I/O	R/W	Timer 1 Compare
0x0218		32	I/O	R/W	Timer 2 Value (@ CPU Clock)
0x021C		32	I/O	R/W	Timer 2 Compare
0x0220		32	I/O	R/W	Timer 3 Value (@ SOF Clock) – Frame Counter
0x0224		32	I/O	R/W	Timer 3 Compare
0x0228		32	I/O	R/W	Reserved
0x022C		32	I/O	R/W	Reserved

5. SD Card Controller Registers

Addy Start Offset	Addy End	Size	Type	R/W	Description																																													
0x0300		8	I/O	R/W	Version Reg <p>Major Revision Number [3] ← Bit 7 Major Revision Number [2] ← Bit 6 Major Revision Number [1] ← Bit 5 Major Revision Number [0] ← Bit 4 Minor Revision Number [0] ← Bit 2 Minor Revision Number [1] ← Bit 1 Minor Revision Number [2] ← Bit 0</p>																																													
0x0301		8	I/O	R/W	Master Control Register <p>Reserved ← Bit 7 Reserved ← Bit 6 Reserved ← Bit 5 Reserved ← Bit 4 Reset Controller (1 = Reset) ← Bit 3 Reserved ← Bit 2 Reserved ← Bit 1 Reserved ← Bit 0</p>																																													
0x0302		8	I/O	R/W	Transfer Type <table border="1" style="float: right;"> <thead> <tr> <th>Transfer Type</th> <th>[1]</th> <th>[0]</th> </tr> </thead> <tbody> <tr> <td>Direct Access</td> <td>0</td> <td>0</td> </tr> <tr> <td>Init SD</td> <td>0</td> <td>1</td> </tr> <tr> <td>R/W Read SD Block</td> <td>1</td> <td>0</td> </tr> <tr> <td>R/W Write SD Block</td> <td>1</td> <td>1</td> </tr> </tbody> </table> <p>Reserved ← Bit 7 Reserved ← Bit 6 Reserved ← Bit 5 Reserved ← Bit 4 Transfer Type[0] ← Bit 3 Transfer Type[1] ← Bit 2 Reserved ← Bit 1 Reserved ← Bit 0</p>	Transfer Type	[1]	[0]	Direct Access	0	0	Init SD	0	1	R/W Read SD Block	1	0	R/W Write SD Block	1	1																														
Transfer Type	[1]	[0]																																																
Direct Access	0	0																																																
Init SD	0	1																																																
R/W Read SD Block	1	0																																																
R/W Write SD Block	1	1																																																
0x0303		8	I/O	R/W	Transfer Control Register <p>Reserved ← Bit 7 Reserved ← Bit 6 Reserved ← Bit 5 Reserved ← Bit 4 Start Transaction (Self-Clear) ← Bit 3 Reserved ← Bit 2 Reserved ← Bit 1 Reserved ← Bit 0</p>																																													
0x0304		8	I/O	R	Transfer Status Register <p>Reserved ← Bit 7 Reserved ← Bit 6 Reserved ← Bit 5 Reserved ← Bit 4 1 = Busy ← Bit 3 Reserved ← Bit 2 Reserved ← Bit 1 Reserved ← Bit 0</p>																																													
0x0305		8	I/O	R/W	Transfer Error Register <p>Reserved ← Bit 7 Reserved ← Bit 6 Reserved ← Bit 5 Reserved ← Bit 4 SD_WRITE_ERROR[1] ← Bit 3 SD_WRITE_ERROR[0] ← Bit 2 SD_INIT_ERROR[1] ← Bit 1 SD_INIT_ERROR[0] ← Bit 0</p> <table border="1" style="float: right;"> <thead> <tr> <th>Init Error</th> <th>[1]</th> <th>[0]</th> <th>Read Error</th> <th>[1]</th> <th>[0]</th> <th>Write Error</th> <th>[1]</th> <th>[0]</th> </tr> </thead> <tbody> <tr> <td>No Error</td> <td>0</td> <td>0</td> <td>No Error</td> <td>0</td> <td>0</td> <td>No Error</td> <td>0</td> <td>0</td> </tr> <tr> <td>Init CMD0</td> <td>0</td> <td>1</td> <td>Read CMD</td> <td>0</td> <td>1</td> <td>Write CMD</td> <td>0</td> <td>1</td> </tr> <tr> <td>Init CMD1</td> <td>1</td> <td>0</td> <td>Read Token</td> <td>1</td> <td>0</td> <td>Write Data</td> <td>1</td> <td>0</td> </tr> <tr> <td>Reserved</td> <td>1</td> <td>1</td> <td>Reserved</td> <td>1</td> <td>1</td> <td>Write Busy</td> <td>X</td> <td>X</td> </tr> </tbody> </table>	Init Error	[1]	[0]	Read Error	[1]	[0]	Write Error	[1]	[0]	No Error	0	0	No Error	0	0	No Error	0	0	Init CMD0	0	1	Read CMD	0	1	Write CMD	0	1	Init CMD1	1	0	Read Token	1	0	Write Data	1	0	Reserved	1	1	Reserved	1	1	Write Busy	X	X
Init Error	[1]	[0]	Read Error	[1]	[0]	Write Error	[1]	[0]																																										
No Error	0	0	No Error	0	0	No Error	0	0																																										
Init CMD0	0	1	Read CMD	0	1	Write CMD	0	1																																										
Init CMD1	1	0	Read Token	1	0	Write Data	1	0																																										
Reserved	1	1	Reserved	1	1	Write Busy	X	X																																										
0x0306		8	I/O	R/W	Direct Access Data Register TX_Data[7:0] (W) Set TX_DATA prior to starting a DIRECT_ACCESS transaction. Note that the SPI bus has no concept of a read or write transaction. Thus every DIRECT_ACCESS transaction transmits data from the SPI master, and receives data from the SPI slave. RX_Data[7:0] (R) Read RX_DATA after completing a DIRECT_ACCESS transaction.																																													
0x0307		8	I/O	R/W	SD Address Register [7:0] Normally set to zero, because memory accesses should occur on a 512 bytes boundary. Set the SD/MMC memory address before starting a block read or block write.																																													

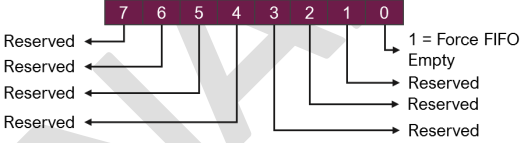
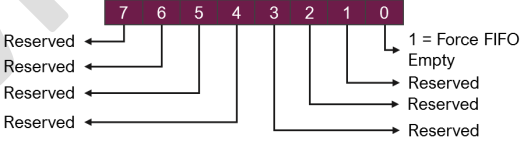
0x0308		8	I/O	R/W	SD Address Register [15:8] Normally set SD_ADDR[8] to zero, because memory accesses should occur on a 512 bytes boundary.
0x0309		8	I/O	R/W	SD Address Register [23:16]
0x030A		8	I/O	R/W	SD Address Register [31:24]
0x030B		8	I/O	R/W	SPI Clock Del Register SPI_CLK_DEL controls the frequency of the SPI_CLK after SD initialization is completed. $SPI_CLK_DEL = (spiSysClk / (SPI_CLK * 2)) - 1$
0x0310		8	I/O	R	Reception FIFO Data Register SD/MMC block read data. Note, FIFO size matches the SD/MMC block size of 512 bytes.
0x0312		8	I/O	R/W	Reception FIFO Data Count Register [15:8] MSB of FIFO_DATA_COUNT. Indicates the number of data entries within the FIFO.
0x0313		8	I/O	R/W	Reception FIFO Data Count Register [7:0] LSB of FIFO_DATA_COUNT. Indicates the number of data entries within the FIFO.
0x0314		8	I/O	R/W	Reception FIFO Control Register  <p>Deletes all the data samples within the FIFO. Self clearing.</p>
0x0320		8	I/O	R/W	Transmission FIFO Data Register SD/MMC block write data. FIFO size matches the SD/MMC block size of 512 bytes.
0x0324		8	I/O	R/W	Transmission FIFO Control Register  <p>Deletes all the data samples within the FIFO. Self clearing.</p>

6. IDE Control Registers

(For more detail on how to use the IDE, please consult the official PATA documentation)

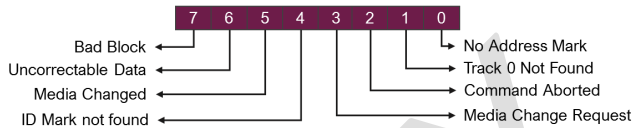
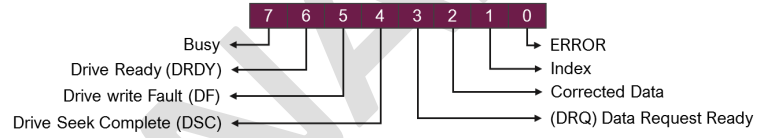
Addy Start Offset	Addy End	Size	Type	R/W	Description
0x0400		16	I/O	R/W	IDE Data Register
0x0402		8	I/O	R/W	IDE Error 
0x0404		8	I/O	R/W	IDE Sector CNT
0x0406		8	I/O	R/W	IDE Sector SRT / LBA0
0x0408		8	I/O	R/W	IDE Cylinder Low / LBA1
0x040A		8	I/O	R/W	IDE Cylinder Hi / LBA2
0x040C		8	I/O	R/W	IDE Head / DEVSEL
0x040E		8	I/O	R/W	IDE CMD (W) /STAT (R)  <p>For the Command list, refer to the official PATA Documentation.</p>

7. JOYSTICK Control Registers

Addy Start Offset	Addy End	Size	Type	R/W	Description
0x0500		16	I/O	R/W	Atari Style DB9 Joystick Port 0 & 1 Data Input
0x0502		16	I/O	R	Reserved - Reads: 0x0000
0x0504		16	I/O	R/W	NES/SNES Control Register & Status
0x0506		16	I/O	R	Reserved - Reads: 0x0000
0x0508		16	I/O	R	NES/SNES Port 0 - Input 0 (When using Joypad Adapter)
0x050A		16	I/O	R	NES/SNES Port 0 - Input 1 (When using Joypad Adapter)
0x050C		16	I/O	R	NES/SNES Port 0 - Input 2 (When using Joypad Adapter)
0x050E		16	I/O	R	NES/SNES Port 0 - Input 3 (When using Joypad Adapter)
0x0510		16	I/O	R	NES/SNES Port 1 - Input 0 (When using Joypad Adapter)
0x0512		16	I/O	R	NES/SNES Port 1 - Input 1 (When using Joypad Adapter)
0x0514		16	I/O	R	NES/SNES Port 1 - Input 2 (When using Joypad Adapter)
0x0516		16	I/O	R	NES/SNES Port 1 - Input 3 (When using Joypad Adapter)

<p>0x0518</p>		<p>16</p>	<p>I/O</p>	<p>R</p>	<p>DIP Switch Value</p>
<p>0x051A</p>		<p>16</p>	<p>I/O</p>	<p>R</p>	<p>SD Card Write Protect & Card Detect Switch Value</p>
<p>0x051C</p>		<p>16</p>	<p>I/O</p>	<p>R</p>	<p>Reserved - Reads: 0x5555</p>
<p>0x051E</p>		<p>16</p>	<p>I/O</p>	<p>R</p>	<p>Reserved - Reads: 0xAAAA</p>

PRELIMINARY

8. PS2 Controller + Simple UART

(For more detail on the PS2 Controller, consult the official documentation)

(For more detail on the Simple UART, consult the official 16550 datasheet)

Addy Start Offset	Addy End	Size	Type	R/W	Description
PS2 Controller					
0x2800		8	I/O	R/W	Keyboard/Mouse Output Buffer (W) Keyboard/Mouse Input Buffer (R) Keyboard/Mouse Data Buffer (R/W)
0x2804		8	I/O	R/W	Keyboard/Mouse Status Port (R) Keyboard/Mouse CMD Port (W)
Simple UART (Compatible with 16550)					
0x28F8		8	I/O	R/W	(RHR) Receiver Holding Register (R) (THR) Transmitter Holding Register (W)
0x28F9		8	I/O	R/W	(IER) Interrupt Enable Register
0x28FA		8	I/O	R/W	(ISR) Interrupt Status Register (R) (FCR) FIFO Control Register (FIFO is 16 Bytes Deep) (W)
0x28FB		8	I/O	R/W	(LCR) Line Control Register
0x28FC		8	I/O	R/W	(MCR) Modem Control Register
0x28FD		8	I/O	R	(LSR) Line Status Register
0x28FE		8	I/O	R/W	(MSR) Modem Status Register
0x28FF		8	I/O	R/W	(SPR) Scratch Pad Register
When DLAB = 1					
0x28F8		8	I/O	R/W	(DLL) Baud rate Divisor's Constant LSB
0x28F9		8	I/O	R/W	(DLM) Baud rate Divisor's Constant MSB
0x28FD		8	I/O	W	(PSD) Pre-Scaler Division

9. Fixed-Point Math Processing Block

Addy Start Offset	Addy End	Size	Type	R/W	Description
UNSIGNED MULTIPLICATION					
0x3000		32	I/O	R/W	Operand A
0x3004		32	I/O	R/W	Operand B
0x3008		32	I/O	R/W	Results [31:0] Low
0x300C		32	I/O	R/W	Results [63:32] Hi
SIGNED MULTIPLICATION					
0x3020		32	I/O	R/W	Operand A
0x3024		32	I/O	R/W	Operand B
0x3028		32	I/O	R/W	Results [31:0] Low
0x302C		32	I/O	R/W	Results [63:32] Hi
UNSIGNED DIVISION					
0x3040		32	I/O	R/W	Operand A
0x3044		32	I/O	R/W	Operand B
0x3048		32	I/O	R/W	Quotient Results [31:0]
0x304C		32	I/O	R/W	Remain Results [31:0]
SIGNED DIVISION					
0x3060		32	I/O	R/W	Operand A
0x3064		32	I/O	R/W	Operand B
0x3068		32	I/O	R/W	Quotient Results [31:0]
0x306C		32	I/O	R/W	Remain Results [31:0]

10. Float-Point Math Processing Block

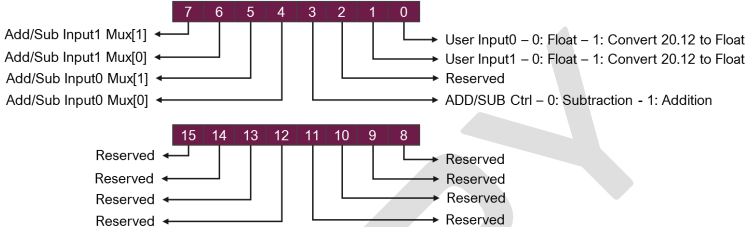
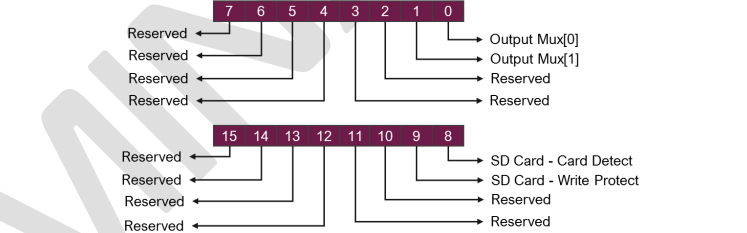
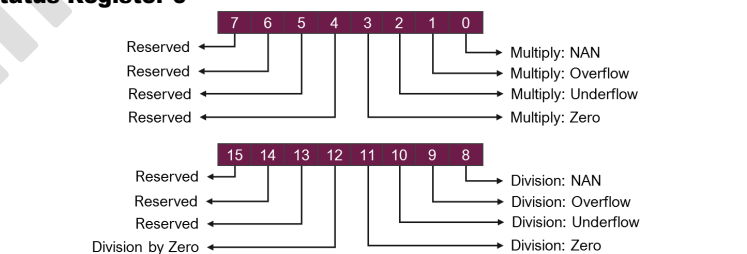
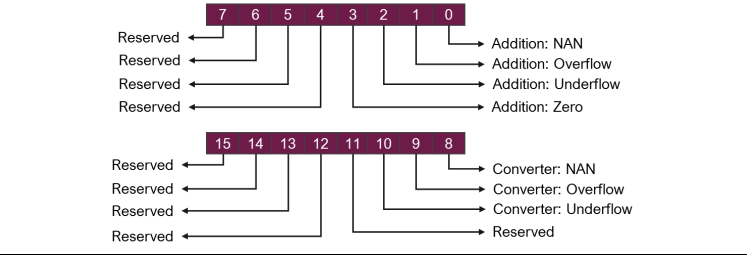
Addy Start Offset	Addy End	Size	Type	R/W	Description																																													
Control Registers																																																		
0x4000		16	I/O	R/W	Control Register 0  <table border="1" data-bbox="695 703 1464 808"> <thead> <tr> <th>Input0 Mux</th> <th>[1]</th> <th>[0]</th> <th>Input 1 Mux</th> <th>[1]</th> <th>[0]</th> <th>Output Mux</th> <th>[1]</th> <th>[0]</th> </tr> </thead> <tbody> <tr> <td>Input Mux 0</td> <td>0</td> <td>0</td> <td>Input Mux 0</td> <td>0</td> <td>0</td> <td>Multiply Out</td> <td>0</td> <td>0</td> </tr> <tr> <td>Input Mux 1</td> <td>0</td> <td>1</td> <td>Input Mux 1</td> <td>0</td> <td>1</td> <td>Division Out</td> <td>0</td> <td>1</td> </tr> <tr> <td>Multiply Out</td> <td>1</td> <td>0</td> <td>Multiply Out</td> <td>1</td> <td>0</td> <td>Add/Sub Out</td> <td>1</td> <td>0</td> </tr> <tr> <td>Division Out</td> <td>1</td> <td>1</td> <td>Division Out</td> <td>1</td> <td>1</td> <td>Value '1' in Float</td> <td>1</td> <td>1</td> </tr> </tbody> </table>	Input0 Mux	[1]	[0]	Input 1 Mux	[1]	[0]	Output Mux	[1]	[0]	Input Mux 0	0	0	Input Mux 0	0	0	Multiply Out	0	0	Input Mux 1	0	1	Input Mux 1	0	1	Division Out	0	1	Multiply Out	1	0	Multiply Out	1	0	Add/Sub Out	1	0	Division Out	1	1	Division Out	1	1	Value '1' in Float	1	1
Input0 Mux	[1]	[0]	Input 1 Mux	[1]	[0]	Output Mux	[1]	[0]																																										
Input Mux 0	0	0	Input Mux 0	0	0	Multiply Out	0	0																																										
Input Mux 1	0	1	Input Mux 1	0	1	Division Out	0	1																																										
Multiply Out	1	0	Multiply Out	1	0	Add/Sub Out	1	0																																										
Division Out	1	1	Division Out	1	1	Value '1' in Float	1	1																																										
0x4002		16	I/O	R/W	Control Register 1 																																													
Status Registers																																																		
0x4004		16	I/O	R	Status Register 0 																																													
0x4006		16	I/O	R	Status Register 1 																																													
User Input																																																		
0x4008		32	I/O	W	User Input 0 (IEEE Float Input or 20.12 Fixed-Point Input)																																													
0x400C		32	I/O	W	User Input 1 (IEEE Float Input or 20.12 Fixed-Point Input)																																													
User Output																																																		
0x4008		32	I/O	R	User Output (IEEE Float Output)																																													
0x400C		32	I/O	R	User Output (Fixed-Point 20.12 Output)																																													

BEATRIX Address Offset: 0x00B2

11. BEATRIX Control Registers

Addr Start Offset	Addr End	Size	Type	R/W	Description
0x0000			I/O	R/W	TBD
0x0000			I/O	R/W	TBD
0x0000			I/O	R/W	TBD
0x0000			I/O	R/W	TBD
0x0000			I/O	R/W	TBD
0x0000			I/O	R/W	TBD
0x0000			I/O	R/W	TBD
0x0000			I/O	R/W	TBD
0x0000			I/O	R/W	TBD
0x0000			I/O	R/W	TBD
0x0000			I/O	R/W	TBD
0x0000			I/O	R/W	TBD
0x0000			I/O	R/W	TBD
0x0000			I/O	R/W	TBD

PRELIMINARY

12. PSG (SN76489) Control Registers

(For Detailed information about the part's registers, please consult the SN76489 Datasheet)

Addy Start Offset	Addy End	Size	Type	R/W	Description
0x0110		8	I/O	W	Internal (FPGA) PSG – LEFT Channel
0x0120		8	I/O	W	Internal (FPGA) PSG – RIGHT Channel
0x0130		8	I/O	W	Internal (FPGA) PSG – MONO Channel When writing here, both Channels are written to at the same time.

13. OPL3 Control Registers

(For Detailed information about the part's registers, please consult the OPL3 Datasheet)

Addy Start Offset	Addy End	Size	Type	R/W	Description
					RIGHT Channel (Registers summarized)
0x0201		8	I/O	W	TEST
0x0202		8	I/O	W	TIMER-1
0x0203		8	I/O	W	TIMER-2
0x0204		8	I/O	W	IRQ
0x0205		8	I/O	W	Set OPL3 Mode
0x0208		8	I/O	W	CSM
0x0220		8	I/O	W	AM/VID/EG/KSR/MULT
0x0240		8	I/O	W	KSL/TL
0x0260		8	I/O	W	AR/DR
0x0280		8	I/O	W	SL/RR
0x02A0		8	I/O	W	F-Number
0x02B0		8	I/O	W	KON/BLOCK/F-Number
0x02BD		8	I/O	W	DEPTH/Rythm
0x02C0		8	I/O	W	FEEDBACK
0x02E0		8	I/O	W	WAVE/SELECT
					LEFT Channel (Registers summarized)
0x0301		8	I/O	W	TEST
0x0302		8	I/O	W	TIMER-1
0x0303		8	I/O	W	TIMER-2
0x0304		8	I/O	W	IRQ
0x0305		8	I/O	W	
0x0308		8	I/O	W	CSM
0x0320		8	I/O	W	AM/VID/EG/KSR/MULT
0x0340		8	I/O	W	KSL/TL
0x0360		8	I/O	W	AR/DR
0x0380		8	I/O	W	SL/RR
0x03A0		8	I/O	W	F-Number
0x03B0		8	I/O	W	KON/BLOCK/F-Number
0x03BD		8	I/O	W	DEPTH/Rythm
0x03C0		8	I/O	W	FEEDBACK
0x03E0		8	I/O	W	WAVE/SELECT

14. CODEC Control Registers

(For Detailed information about the part's registers, please consult the WM8776SEFT/V Datasheet)

Addr Start Offset	Addr End	Size	Type	R/W	Description
0x0E00		16	I/O	W	DATA Register (Data is serialized to the CODEC after the Write Transaction is completed)
0x0E00		16	I/O	R	STATUS <p>Check for the busy flag to go back to '0' before sending another command</p>

15. SID Control Registers

(For Detailed information about the part's registers, please consult the CBM6581 Datasheet)

Addy Start Offset	Addy End	Size	Type	R/W	Description
LEFT Channel (Registers summarized)					
0x1000		8	I/O	R/W	Voice 1 - FREQ LOW
0x1001		8	I/O	R/W	Voice 1 - FREQ HI
0x1002		8	I/O	R/W	Voice 1 - PW LO
0x1003		8	I/O	R/W	Voice 1 - PW HI
0x1004		8	I/O	R/W	Voice 1 - Control
0x1005		8	I/O	R/W	Voice 1 - Attack / Decay
0x1006		8	I/O	R/W	Voice 1 - Sustain / Release
0x1007		8	I/O	R/W	Voice 2 - FREQ LOW
0x1008		8	I/O	R/W	Voice 2 - FREQ HI
0x1009		8	I/O	R/W	Voice 2 - PW LO
0x100A		8	I/O	R/W	Voice 2 - PW HI
0x100B		8	I/O	R/W	Voice 2 - Control
0x100C		8	I/O	R/W	Voice 2 - Attack / Decay
0x100D		8	I/O	R/W	Voice 2 - Sustain / Release
0x100E		8	I/O	R/W	Voice 3 - FREQ LOW
0x100F		8	I/O	R/W	Voice 3 - FREQ HI
0x1010		8	I/O	R/W	Voice 3 - PW LO
0x1011		8	I/O	R/W	Voice 3 - PW HI
0x1012		8	I/O	R/W	Voice 3 - Control
0x1013		8	I/O	R/W	Voice 3 - Attack / Decay
0x1014		8	I/O	R/W	Voice 3 - Sustain / Release
0x1015		8	I/O	R/W	Filter - FC LOW
0x1016		8	I/O	R/W	Filter - FC HI
0x1017		8	I/O	R/W	Filter - RES / FILT
0x1018		8	I/O	R/W	Filter - Mode / VOL
0x1019		8	I/O	R/W	POT X (not Supported)
0x101A		8	I/O	R/W	POT Y (not Supported)
0x101B		8	I/O	R/W	OSC3 / RANDOM
0x101C		8	I/O	R/W	ENV3
0x101D		8	I/O	R/W	Reserved
0x101E		8	I/O	R/W	Reserved
0x101F		8	I/O	R/W	Reserved
RIGHT Channel (Registers summarized)					
0x1200		8	I/O	R/W	Voice 1 - FREQ LOW
0x1201		8	I/O	R/W	Voice 1 - FREQ HI
0x1202		8	I/O	R/W	Voice 1 - PW LO
0x1203		8	I/O	R/W	Voice 1 - PW HI
0x1204		8	I/O	R/W	Voice 1 - Control
0x1205		8	I/O	R/W	Voice 1 - Attack / Decay
0x1206		8	I/O	R/W	Voice 1 - Sustain / Release
0x1207		8	I/O	R/W	Voice 2 - FREQ LOW
0x1208		8	I/O	R/W	Voice 2 - FREQ HI
0x1209		8	I/O	R/W	Voice 2 - PW LO
0x120A		8	I/O	R/W	Voice 2 - PW HI
0x120B		8	I/O	R/W	Voice 2 - Control
0x120C		8	I/O	R/W	Voice 2 - Attack / Decay
0x120D		8	I/O	R/W	Voice 2 - Sustain / Release
0x120E		8	I/O	R/W	Voice 3 - FREQ LOW

0x120F		8	I/O	R/W	Voice 3 - FREQ HI
0x1210		8	I/O	R/W	Voice 3 – PW LO
0x1211		8	I/O	R/W	Voice 3 – PW HI
0x1212		8	I/O	R/W	Voice 3 - Control
0x1213		8	I/O	R/W	Voice 3 – Attack / Decay
0x1214		8	I/O	R/W	Voice 3 – Sustain / Release
0x1215		8	I/O	R/W	Filter – FC LOW
0x1216		8	I/O	R/W	Filter – FC HI
0x1217		8	I/O	R/W	Filter – RES / FILT
0x1218		8	I/O	R/W	Filter – Mode / VOL
0x1219		8	I/O	R/W	POT X (not Supported)
0x121A		8	I/O	R/W	POT Y (not Supported)
0x121B		8	I/O	R/W	OSC3 / RANDOM
0x121C		8	I/O	R/W	ENV3
0x121D		8	I/O	R/W	Reserved
0x121E		8	I/O	R/W	Reserved
0x121F		8	I/O	R/W	Reserved
MONO Channel (Registers summarized)					
0x1400	0x141F	8	I/O	R/W	When writing here, both Channels are written to at the same time.

16. DAC Control Registers (48Khz Sampling)

Addy Start Offset	Addy End	Size	Type	R/W	Description
0x2000		8	I/O	R/W	TBD
0x2001		8	I/O	R/W	TBD
0x2002		8	I/O	R/W	TBD
0x2003		8	I/O	R/W	TBD
0x2004		8	I/O	R/W	TBD
0x2005		8	I/O	R/W	TBD
0x2006		8	I/O	R/W	TBD
0x2007		8	I/O	R/W	TBD

VICKY II Address Offset: 0x00B4

1. System Control Register

Addy Start Offset	Addy End	Size	Type	R/W	Description															
0x0000		32	I/O	R/W	<table border="1" style="margin-top: 10px;"> <thead> <tr> <th>Video Mode</th> <th>[1]</th> <th>[0]</th> </tr> </thead> <tbody> <tr> <td>640x480 @ 60FPS</td> <td>0</td> <td>0</td> </tr> <tr> <td>800x600 @ 60FPS</td> <td>0</td> <td>1</td> </tr> <tr> <td>Reserved</td> <td>1</td> <td>0</td> </tr> <tr> <td>640x400 @ 70FPS</td> <td>1</td> <td>1</td> </tr> </tbody> </table>	Video Mode	[1]	[0]	640x480 @ 60FPS	0	0	800x600 @ 60FPS	0	1	Reserved	1	0	640x400 @ 70FPS	1	1
Video Mode	[1]	[0]																		
640x480 @ 60FPS	0	0																		
800x600 @ 60FPS	0	1																		
Reserved	1	0																		
640x400 @ 70FPS	1	1																		
0x0004		32	I/O	R/W	Border Control Register															
0x0008		32	I/O	R/W	Border Color Register															

0x000C		32	I/O	R/W	<p>Background Color Register</p>
0x0010		32	I/O	R/W	<p>Cursor Control Register</p> <p> ** : Not Implemented Yet </p>

				Flash Rate	
				[1]	[0]
				1 Sec	0 0
				½ sec	0 1
				¼ sec	1 0
				1/5 sec	1 1
0x0014		32	I/O	R/W	<p>Cursor Position Register</p>
0x0018		16	I/O	R/W	<p>Line Interrupt Register 0</p>
0x001A		16	I/O	R/W	<p>Line Interrupt Register 1</p>
0x001C		16	I/O	R/W	<p>Line Interrupt Register 2</p>
0x001E		16	I/O	R/W	<p>Line Interrupt Register 3</p>

A2560 FOENIX U - User Manual

0x0020		16	I/O	R/W	Reserved
0x0022		16	I/O	R/W	Reserved
0x0024		16	I/O	R/W	Reserved
0x0026		16	I/O	R/W	Reserved
0x0028		16	I/O	R/W	Reserved
0x002A		16	I/O	R/W	Reserved
0x002C		16	I/O	R/W	Reserved
0x002E		16	I/O	R/W	Reserved
0x0030		16	I/O	R/W	FPGA Load Date 4x BCD Numbers - Year
0x0032		16	I/O	R/W	FPGA Load Date 2x BCD Numbers – Month / 2x BCD Numbers Day
0x0034		16	I/O	R/W	PCB Revision in ASCII – Example: “A0”
0x0036		16	I/O	R/W	PCB Revision in ASCII – Example: “A” + “\n”
0x0038		16	I/O	R/W	FPGA Sub-Version - 4x BCD Numbers
0x003A		16	I/O	R/W	FPGA Version - 4x BCD Numbers
0x003C		16	I/O	R/W	FPGA Chip Part Number (low) - 4x BCD Numbers – “5171”
0x003E		16	I/O	R/W	FPGA Chip Part Number (hi) - 4x BCD Numbers – “0009”

1. Bitmap Control Registers

Addy Start Offset	Addy End	Size	Type	R/W	Description
0x0100		32	I/O	R/W	Bitmap Layer0 Control Register (Foreground Layer)
0x0104		32	I/O	R/W	Bitmap Layer0 VRAM Address Pointer Offset within the VRAM memory from VICKY's perspective VRAM Address begins @ \$00:0000 and ends @ \$1FFFFFF <i>Always position the bitmap within a 32bits Boundary address.</i>
0x0108		32	I/O	R/W	Bitmap Layer1 Control Register (Background Layer)
0x000C		32	I/O	R/W	Bitmap Layer1 VRAM Address Pointer Offset within the VRAM memory from VICKY's perspective VRAM Address begins @ \$00:0000 and ends @ \$1FFFFFF <i>Always position the bitmap within a 32bits Boundary address.</i>
0x0010		32	I/O	R/W	Bitmap Collision Layer Control Register (Not Implemented)
0x0014		32	I/O	R/W	Bitmap Collision Layer VRAM Address Pointer (Not Implemented)

2. Tile Map Control Registers

Addy Start Offset	Addy End	Size	Type	R/W	Description
0x0200		16	I/O	W	Tile Map Layer0 Control Register (Foreground Layer) <p>Note: The LUT is defined in each tile Attributes Bit field [13:11] The Tile Set is also defined in each tile Attributes bit field [10:8] The Master Collision bit is defined here, but each tile needs to be turn on for collision control by setting bit [14] in the Tile 16bits definition.</p>
0x0204		32	I/O	W	Tile Map Layer0 VRAM Address Pointer Offset within the VRAM memory from VICKY's perspective VRAM Address begins @ \$000000 and ends @ \$1FFFFFF <i>Always position the Map within a 16bits Boundary address.</i>
0x0208		16	I/O	W	Tile Map Layer0 X Map Size
0x020A		16	I/O	W	Tile Map Layer0 Y Map Size
0x020C		16	I/O	W	Tile Map Layer0 X Position
0x020E		16	I/O	W	Tile Map Layer0 Y Position

0x0210	16	I/O	W	Tile Map Layer1 Control Register (Mid-Layer0)	
0x0214	32	I/O	W	Tile Map Layer1 VRAM Address Pointer Offset within the VRAM memory from VICKY's perspective VRAM Address begins @ \$000000 and ends @ \$1FFFFFF <i>Always position the Map within a 16bits Boundary address.</i>	
0x0218	16	I/O	W	Tile Map Layer1 X Map Size	
0x021A	16	I/O	W	Tile Map Layer1 Y Map Size	
0x021C	16	I/O	W	Tile Map Layer1 X Position	
0x021E	16	I/O	W	Tile Map Layer1 Y Position	
0x0220	16	I/O	W	Tile Map Layer2 Control Register (Mid-Layer1)	
0x0224	32	I/O	W	Tile Map Layer2 VRAM Address Pointer Offset within the VRAM memory from VICKY's perspective VRAM Address begins @ \$000000 and ends @ \$1FFFFFF <i>Always position the Map within a 16bits Boundary address.</i>	
0x0228	16	I/O	W	Tile Map Layer2 X Map Size	
0x022A	16	I/O	W	Tile Map Layer2 Y Map Size	
0x022C	16	I/O	W	Tile Map Layer2 X Position	
0x022E	16	I/O	W	Tile Map Layer2 Y Position	
0x0230	16	I/O	W	Tile Map Layer3 Control Register (Background Layer)	
0x0234	32	I/O	W	Tile Map Layer3 VRAM Address Pointer Offset within the VRAM memory from VICKY's perspective VRAM Address begins @ \$000000 and ends @ \$1FFFFFF <i>Always position the Map within a 16bits Boundary address.</i>	
0x0238	16	I/O	W	Tile Map Layer3 X Map Size	
0x023A	16	I/O	W	Tile Map Layer3 Y Map Size	
0x023C	16	I/O	W	Tile Map Layer3 X Position	
0x023E	16	I/O	W	Tile Map Layer3 Y Position	
0x0280	32	I/O	W	Tile Graphics Set Addy Pointer 0 	
0x0284	32	I/O	W	Tile Graphics Set Addy Pointer 1	

A2560 FOENIX U - User Manual

0x0288		32	I/O	W	Tile Graphics Set Addy Pointer 2
0x028C		32	I/O	W	Tile Graphics Set Addy Pointer 3
0x0290		32	I/O	W	Tile Graphics Set Addy Pointer 4
0x0294		32	I/O	W	Tile Graphics Set Addy Pointer 5
0x0298		32	I/O	W	Tile Graphics Set Addy Pointer 6
0x029C		32	I/O	W	Tile Graphics Set Addy Pointer 7

PRELIMINARY

3. Collision Status Registers

Addy Start Offset	Addy End	Size	Type	R/W	Description
0x0300	0x03FF	16	I/O	W	To Be documented

PRELIMINARY

4. Mouse Pointer Graphic Memory

Addy Start Offset	Addy End	Size	Type	R/W	Description
0x0400	0x0BFF	16	MEM	W	16x16 – Full color Mouse Pointer Memory Pointer

5. Mouse Control Registers

Addy Start Offset	Addy End	Size	Type	R/W	Description
0x0C00		16	I/O	R/W	Mouse Pointer Control Register
0x0C02		16	I/O	R	Mouse Pointer X Position
0x0C04		16	I/O	R	Mouse Pointer Y Position
0x0C06		16	I/O	R	Reserved
0x0C08		16	I/O	R	Reserved
0x0C0A		16	I/O	R/W	PS2 Mouse Byte 0
0x0C0C		16	I/O	R/W	PS2 Mouse Byte 1
0x0C0E		16	I/O	R/W	PS2 Mouse Byte 2

6. Sprites Control Registers

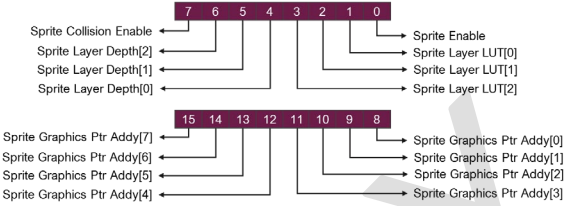
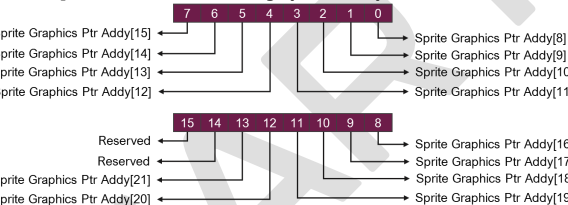
Addy Start Offset	Addy End	Size	Type	R/W	Description
0x1000		16	I/O	W	Sprite 0 Control Register + Pointer Addy Low – Top Priority 
0x1002		16	I/O	W	Sprite 0 Graphics Pointer Addy (Hi Part)  <p><i>Always position the Pointer within a 16bits Boundary address.</i></p>
0x1004		16	I/O	W	Sprite 0 X Position Note: The position 0,0 of a sprite is -32, -32 offscreen
0x1006		16	I/O	W	Sprite 0 Y Position Note: The position 0,0 of a sprite is -32, -32 offscreen
0x1008	0x100E	16	I/O	W	Sprite 1
0x1010	0x1016	16	I/O	W	Sprite 2
0x1018	0x101E	16	I/O	W	Sprite 3
0x1020	0x1026	16	I/O	W	Sprite 4
0x1028	0x102E	16	I/O	W	Sprite 5
0x1030	0x1036	16	I/O	W	Sprite 6
0x1038	0x103E	16	I/O	W	Sprite 7
0x1040	0x1046	16	I/O	W	Sprite 8
0x1048	0x104E	16	I/O	W	Sprite 9
0x1050	0x1056	16	I/O	W	Sprite 10
0x1058	0x105E	16	I/O	W	Sprite 11
0x1060	0x1066	16	I/O	W	Sprite 12
0x1068	0x106E	16	I/O	W	Sprite 13
0x1070	0x1076	16	I/O	W	Sprite 14
0x1078	0x107E	16	I/O	W	Sprite 15
0x1080	0x1086	16	I/O	W	Sprite 16
0x1088	0x108E	16	I/O	W	Sprite 17
0x1090	0x1096	16	I/O	W	Sprite 18
0x1098	0x109E	16	I/O	W	Sprite 19
0x10A0	0x10A6	16	I/O	W	Sprite 20
0x10A8	0x10AE	16	I/O	W	Sprite 21
0x10B0	0x10B6	16	I/O	W	Sprite 22
0x10B8	0x10BE	16	I/O	W	Sprite 23
0x10C0	0x10C6	16	I/O	W	Sprite 24
0x10C8	0x10CE	16	I/O	W	Sprite 25
0x10D0	0x10D6	16	I/O	W	Sprite 26
0x10D8	0x10DE	16	I/O	W	Sprite 27
0x10E0	0x10E6	16	I/O	W	Sprite 28
0x10E8	0x10EE	16	I/O	W	Sprite 29
0x10F0	0x10F6	16	I/O	W	Sprite 30

A2560 FOENIX U – User Manual

0x10F8	0x10FE	16	I/O	W	Sprite 31
0x1100	0x1106	16	I/O	W	Sprite 32
0x1108	0x110E	16	I/O	W	Sprite 33
0x1110	0x1116	16	I/O	W	Sprite 34
0x1118	0x111E	16	I/O	W	Sprite 35
0x1120	0x1126	16	I/O	W	Sprite 36
0x1128	0x112E	16	I/O	W	Sprite 37
0x1130	0x1136	16	I/O	W	Sprite 38
0x1138	0x113E	16	I/O	W	Sprite 39
0x1140	0x1146	16	I/O	W	Sprite 40
0x1148	0x114E	16	I/O	W	Sprite 41
0x1150	0x1156	16	I/O	W	Sprite 42
0x1158	0x115E	16	I/O	W	Sprite 43
0x1160	0x1166	16	I/O	W	Sprite 44
0x1168	0x116E	16	I/O	W	Sprite 45
0x1170	0x1176	16	I/O	W	Sprite 46
0x1178	0x117E	16	I/O	W	Sprite 47
0x1180	0x1186	16	I/O	W	Sprite 48
0x1188	0x118E	16	I/O	W	Sprite 49
0x1190	0x1196	16	I/O	W	Sprite 50
0x1198	0x119E	16	I/O	W	Sprite 51
0x11A0	0x11A6	16	I/O	W	Sprite 52
0x11A8	0x11AE	16	I/O	W	Sprite 53
0x11B0	0x11B6	16	I/O	W	Sprite 54
0x11B8	0x11BE	16	I/O	W	Sprite 55
0x11C0	0x11C6	16	I/O	W	Sprite 56
0x11C8	0x11CE	16	I/O	W	Sprite 57
0x11D0	0x11D6	16	I/O	W	Sprite 58
0x11D8	0x11DE	16	I/O	W	Sprite 59
0x11E0	0x11E6	16	I/O	W	Sprite 60
0x11E8	0x11EE	16	I/O	W	Sprite 61
0x11F0	0x11F6	16	I/O	W	Sprite 62
0x11F8	0x11FE	16	I/O	W	Sprite 63 – Least Priority

7. LUT Memory

Addy Start Offset	Addy End	Size	Type	R/W	Description
0x2000	0x23FF	8	MEM	R/W	LUT0 – 256x 32bits ARGB – Offset 0 is always Transparent
0x2400	0x27FF	8	MEM	R/W	LUT1 – 256x 32bits ARGB
0x2800	0x2BFF	8	MEM	R/W	LUT2 – 256x 32bits ARGB
0x2C00	0x2FFF	8	MEM	R/W	LUT3 – 256x 32bits ARGB
0x3000	0x33FF	8	MEM	R/W	LUT4 – 256x 32bits ARGB
0x3400	0x37FF	8	MEM	R/W	LUT5 – 256x 32bits ARGB
0x3800	0x3BFF	8	MEM	R/W	LUT6 – 256x 32bits ARGB
0x3C00	0x3FFF	8	MEM	R/W	LUT7 – 256x 32bits ARGB

8. GAMMA LUT Memory Blocks

Addy Start Offset	Addy End	Size	Type	R/W	Description
0x4000	0x40FF	8	MEM	R/W	GAMMA Correction Blue Channel
0x4100	0x41FF	8	MEM	R/W	GAMMA Correction Green Channel
0x4200	0x42FF	8	MEM	R/W	GAMMA Correction Red Channel

9. FONT Memory Block

Addy Start Offset	Addy End	Size	Type	R/W	Description
0x8000	0x8FFF	8	MEM	R/W	FONT Character Graphics Storage

VICKY II Address Offset: 0x00B6

10. Text Memory Block

Addy Start Offset	Addy End	Size	Type	R/W	Description
0x0000	0x3FFF	8/16	MEM	R/W	Text Mode Character Display Memory

11. Text Color Memory Block

Addy Start Offset	Addy End	Size	Type	R/W	Description
0x8000	0xBFFF	8/16	MEM	R/W	Text Mode Color Display Memory

12. Text Color LUT

Addy Start Offset	Addy End	Size	Type	R/W	Description
0xC400	0xC43F	8/16	MEM	R/W	16x 32Bits Values ARGB for Foreground Colors
0xC440	0xC47F	8/16	MEM	R/W	16x 32Bits Values ARGB for Background Colors

PRELIMINARY