



# A2560 Phoenix K

## USER MANUAL

REVISION 0.0.2

March 31st, 2022

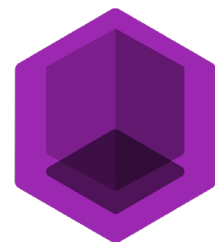

PHOENIX RETRO SYSTEMS

# A2560 FOENIX K - User Manual

| Revision History   | By              | Rev   | Date                            |
|--|-----------------|-------|---------------------------------|
| Alpha Release - Preliminary  | Stefany Allaire | 0.0.0 | January 15 <sup>th</sup> , 2022 |
| Adding of the Keyboard RGB LED Memory Block + Corrections  | Stefany Allaire | 0.0.1 | January 16 <sup>th</sup> , 2022 |
| Error corrections on certain VICKY's registers<br>Ethernet IRQ Addition<br>Mau's RGB Memory layout updated | Stefany Allaire | 0.0.2 | March 31st, 2022                |
|  |                 |       |                                 |
|  |                 |       |                                 |

PRELIMINARY

*This page is left intentionally blank*

PRELIMINARY

## Table of Content

|  |    |
|--|----|
| <i>This page is left intentionally blank</i> ..... | 2  |
| Table of Content.....                              | 3  |
| Table of Pictures.....                             | 6  |
| 1. Unboxing.....                                   | 7  |
| 2. First Look.....                                 | 8  |
| 3. Setup.....                                      | 9  |
| 4. Motherboard.....                                | 10 |
| 5. System Block Diagram.....                       | 11 |
| 6. Devices.....                                    | 12 |
| 7. VICKY III.....                                  | 13 |
| 8. Global Memory Map.....                          | 14 |
| 9. Detailed Memory Map & Registers.....            | 15 |
| 9.1. GAVIN Address Offset: @xFEC0:XXXX.....        | 15 |
| 9.1.1. System Control Registers.....               | 15 |
| 9.1.2. A2560K - (Mau`s) Keyboard register.....     | 17 |
| 9.1.3. Real Time Clock.....                        | 18 |
| 9.1.4. Interrupt Controller Registers.....         | 20 |
| 9.1.5. Timer Controllers Registers.....            | 22 |
| 9.1.6. SD Card Controller Registers.....           | 23 |
| 9.1.7. IDE Control Registers.....                  | 25 |
| 9.1.8. JOYSTICK Control Registers.....             | 26 |
| 9.1.9. Ethernet Controller - LAN9221.....          | 28 |
| 9.1.10. Mau`s ARGB Matrix Memory Block.....        | 28 |
| 9.1.11. SUPER IO - LPC47M107.....                  | 29 |
| 9.1.12. Fixed Math Block.....                      | 30 |
| 9.1.13. Floating Point Math Block.....             | 31 |
| 9.2. BEATRIX Address Offset: @xFEC2:XXXX.....      | 32 |
| 9.2.1. BEATRIX Control Registers.....              | 32 |
| 9.2.2. PSG - SN76489 - Control Registers.....      | 33 |
| 9.2.3. External OPL3 Control Registers.....        | 33 |
| 9.2.4. External OPN2 Control Registers.....        | 34 |

# A2560 FOENIX K - User Manual

|         |  |    |
|---------|--|----|
| 9.2.5.  | External OPM Control Registers.....                  | 34 |
| 9.2.6.  | External Left SID Control Registers.....             | 34 |
| 9.2.7.  | External Right SID Control Registers.....            | 35 |
| 9.2.8.  | Internal OPN2 Control Registers.....                 | 36 |
| 9.2.9.  | Internal OPM Control Registers.....                  | 36 |
| 9.2.10. | CODEC Control Registers.....                         | 36 |
| 9.2.11. | Internal SIDs Control Registers.....                 | 37 |
| 9.2.12. | DAC0 Control Registers (48Khz Sampling).....         | 38 |
| 1.1.1.  | DAC1 Control Registers (44.1KHz Sampling).....       | 38 |
| 9.2.13. | Internal YM2149 Left Control Registers.....          | 39 |
| 9.2.14. | Internal YM2149 Right Control Registers.....         | 39 |
| 9.2.15. | Internal YM2149 ( L = R ) Control Registers.....     | 39 |
| 9.3.    | VICKY III Channel A Address Offset: @xFEC4:XXXX..... | 40 |
| 9.3.1.  | Control Registers.....                               | 40 |
| 9.3.2.  | Mouse Graphic Memory.....                            | 44 |
| 9.3.3.  | Mouse Control Registers.....                         | 44 |
| 9.3.4.  | GAMMA Memory Block.....                              | 45 |
| 9.3.5.  | FONT Memory Block.....                               | 45 |
| 9.4.    | VICKY III Channel A Address Offset: @xFEC6:XXXX..... | 45 |
| 9.4.1.  | Text Memory Block.....                               | 45 |
| 9.4.2.  | Text Color Memory Block.....                         | 45 |
| 9.4.3.  | Text Color LUT.....                                  | 45 |
| 9.5.    | VICKY III Channel B Address Offset: @xFEC8:XXXX..... | 46 |
| 9.5.1.  | Control Registers.....                               | 46 |
| 9.5.2.  | Bitmap Control Registers.....                        | 50 |
| 9.5.3.  | Tile Map Control Registers.....                      | 51 |
| 9.5.4.  | Collision Status Registers.....                      | 54 |
| 9.5.5.  | Mouse Pointer Graphic Memory.....                    | 55 |
| 9.5.6.  | Mouse Control Registers.....                         | 55 |
| 9.5.7.  | Sprites Control Registers.....                       | 56 |
| 9.5.8.  | LUT Memory Block.....                                | 58 |
| 9.5.9.  | GAMMA LUT Memory Block.....                          | 58 |
| 9.5.10. | FONT Memory Block.....                               | 58 |

## A2560 FOENIX K - User Manual

|        |   |    |
|--------|---|----|
| 9.6.   | VICKY III Channel B Address Offset: @xFECA:XXX..... | 58 |
| 9.6.1. | Text Memory Block.....                              | 58 |
| 9.6.2. | Text Color Memory Block.....                        | 58 |
| 9.6.3. | Text Color LUT.....                                 | 58 |

PRELIMINARY

Table of Pictures

PRELIMINARY

## 1. Unboxing

PRELIMINARY



## 2. First Look

PRELIMINARY

### 3. Setup

PRELIMINARY

## 4. Motherboard

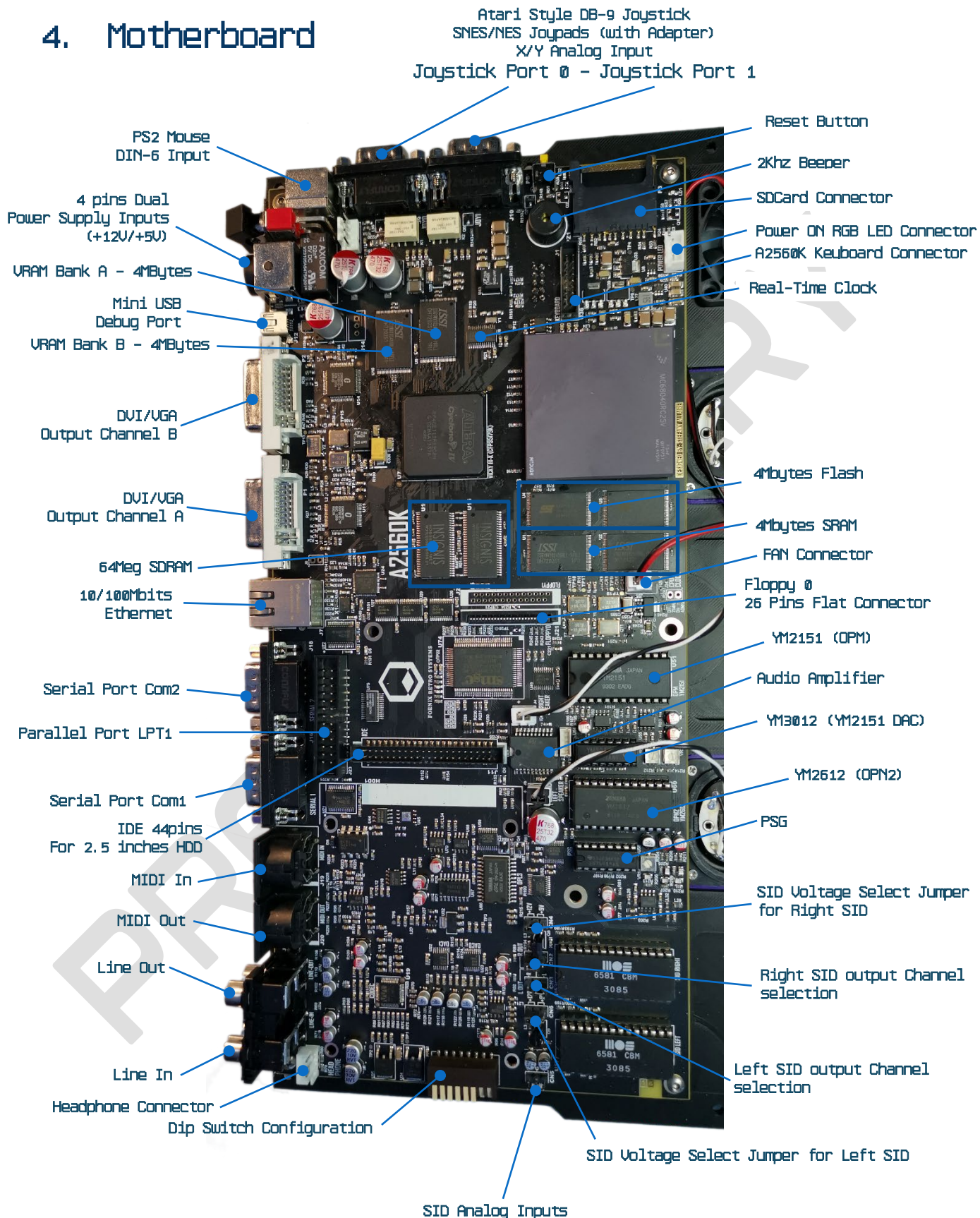

## 5. System Block Diagram

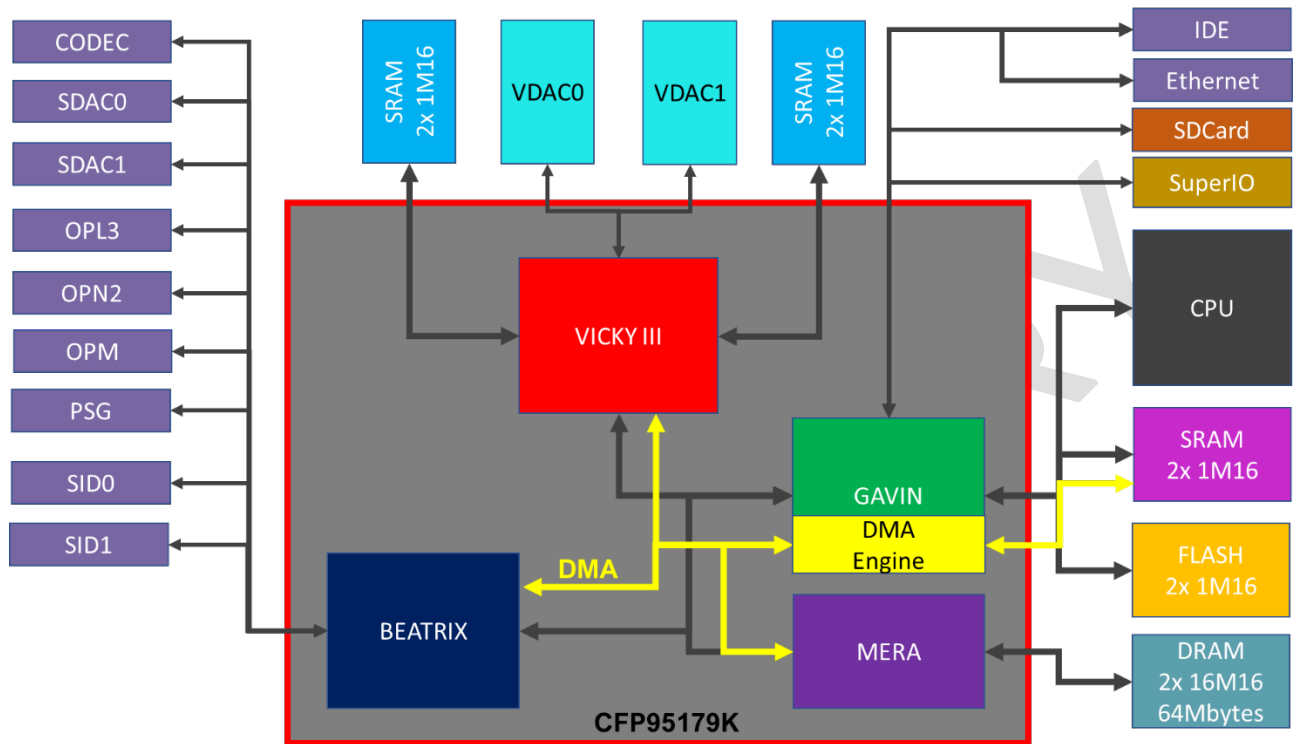

## 6. Devices

### Interrupts

### Timers

TIMER BLOCK  
Block Diagram

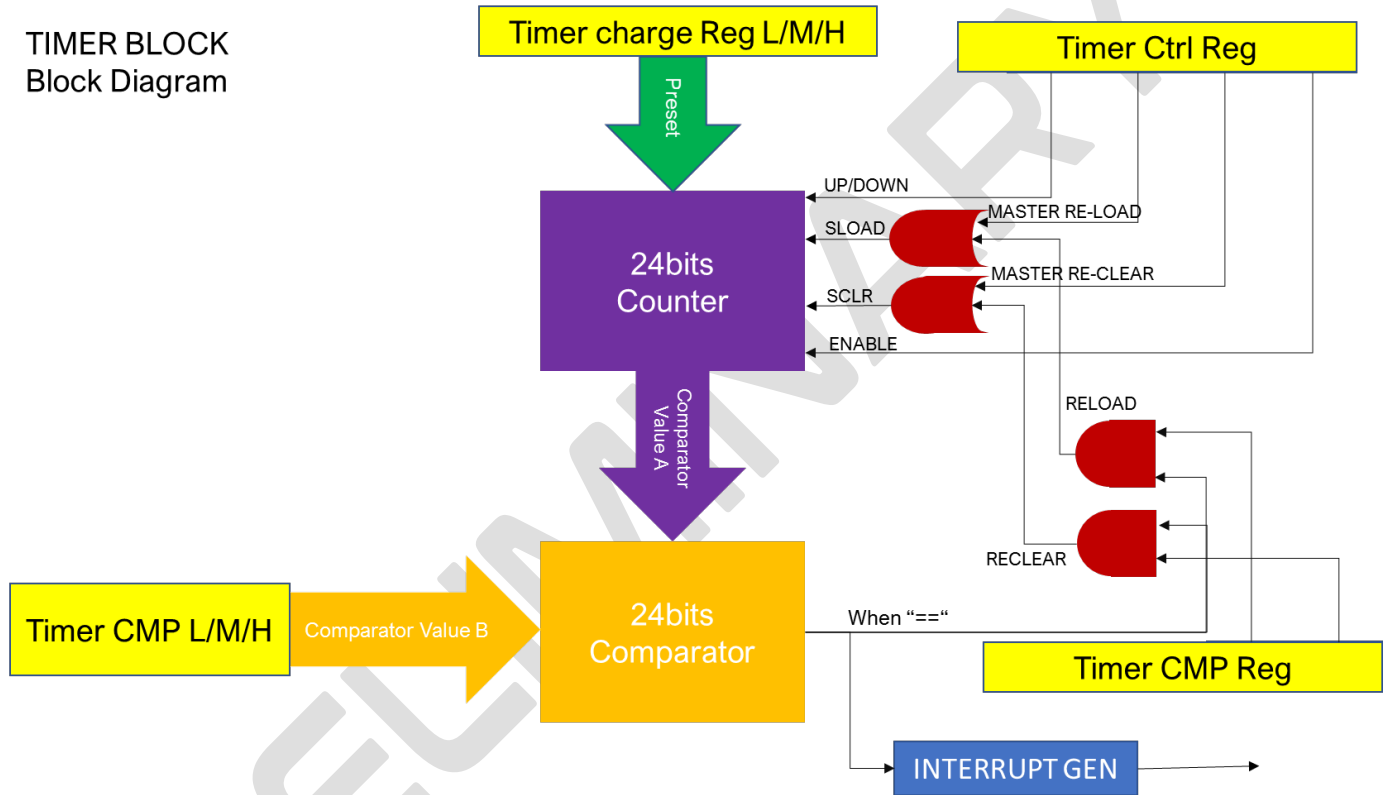

**DMA**

**RTC**

**IDE**

**Ethernet**

## 7. VICKY III

PRELIMINARY

## 8. Global Memory Map

| Addy Start Offset | Addy End    | Size    | Type | R/W | Description                                    |
|-------------------|-------------|---------|------|-----|--|
| 0x0000:0000       | 0x003F_FFFF | 8/16/32 | MEM  | R/W | System RAM - SRAM - 4Meg                       |
| 0x0080:0000       | 0x00BF_FFFF | 8/16/32 | MEM  | R/W | VIDEO RAM Buffer A - SRAM - 4Meg               |
| 0x00C0:0000       | 0x00FF_FFFF | 8/16/32 | MEM  | R/W | VIDEO RAM Buffer B - SRAM - 4Meg               |
| 0x0100:0000       | 0x01FF_FFFF | -       | -    | -   | Empty Space (will trigger an BERR if accessed) |
| 0x0200:0000       | 0x04FF_FFFF | 8/16/32 | MEM  | R/W | 64Mbytes SDRAM                                 |
| 0x0500:0000       | 0xFEBF_FFFF | -       | -    | -   | Empty Space (will trigger an BERR if accessed) |
| 0xFEC0:0000       | 0xFEC1:FFFF | 8/16/32 | I/O  | R/W | GAVIN Registers (System Controller)            |
| 0xFEC2:0000       | 0xFEC3:FFFF | 8/16/32 | I/O  | R/W | BEATRIX Registers (Sound/Music/DAC)            |
| 0xFEC4:0000       | 0xFEC5:FFFF | 8/16/32 | I/O  | R/W | VKY III - Chan A - (Text/Graphics Controller)  |
| 0xFEC6:0000       | 0xFEC6:3FFF | 8       | MEM  | R/W | VKY III - Chan A - Text Memory Block           |
| 0xFEC6:8000       | 0xFEC6:FFFF | 8       | MEM  | R/W | VKY III - Chan A - Text Color Memory Block     |
| 0xFEC8:0000       | 0xFEC9:FFFF | 8/16/32 | I/O  | R/W | VKY III - Chan B - (Text/Graphics Controller)  |
| 0xFECA:0000       | 0xFECA:3FFF | 8       | MEM  | R/W | VKY III - Chan B - Text Memory Block           |
| 0xFECA:8000       | 0xFECA:FFFF | 8       | MEM  | R/W | VKY III - Chan B - Text Color Memory Block     |
| 0xFECA:8000       | 0xFFBF:FFFF | -       | -    | -   | Empty Space (will trigger an BERR if accessed) |
| 0xFFC0:0000       | 0xFFFF:FFFF | 16      | MEM  | R   | FLASH - 4Meg                                   |

## 9. Detailed Memory Map & Registers

### 9.1. GAVIN Address Offset: @xFEC0:XXX

#### 9.1.1. System Control Registers

| Addy Start Offset | Addy End | Size | Type | R/W | Description  |
|-------------------|----------|------|------|-----|--|
| 0x0000            |          | 32   | I/O  | R/W | <p><b>GAVIN Control Register</b></p> <p>Read/Write Value @ Reset: 0x0001</p> <p>Reserved ← 7 6 5 4 3 2 1 0 → On Board Power LED<br/>         Reserved ← On Board SD Card LED<br/>         Reserved ← Reserved<br/>         On Board On/Off Buzzer ← Reserved<br/>         Manual Reset* ← 15 14 13 12 11 10 9 8 → Reserved<br/>         Reserved ← Reserved<br/>         Reserved ← Reserved<br/>         Reserved ← Reserved</p> <p><b>Manual Reset - * Security Word</b><br/>         Value @ [31:16]<br/>         Write the Value: 0xDEAD to unlock the Manual Reset</p>  |
| 0x0004            |          | 32   | I/O  | R/W | <p><b>LFSR Control Register</b></p> <p>Read/Write Value @ Reset: 0x0000</p> <p>Reserved ← 7 6 5 4 3 2 1 0 → LFSR Enable<br/>         Reserved ← SEED Write Bit<br/>         Reserved ← Reserved<br/>         Reserved ← Reserved<br/>         Reserved ← 15 14 13 12 11 10 9 8 → Reserved<br/>         Reserved ← Reserved<br/>         Reserved ← Reserved<br/>         Reserved ← Reserved<br/>         Reserved ← Reserved</p> <p><b>LFSR SEED Value</b><br/>         Value @ [31:16]<br/>         Write a Value to setup the LFSR Seed, then set bit#1 of LFSR Control Register. Then, clear the bit. This will latch the value of the Seed in the LFSR.</p> |
| 0x0008            |          | 32   | I/O  | R   | <p><b>LFSR Output Value [15:0]</b><br/>         Every time you read this register after the LFSR has been enabled and the Seed setup, you will get a new random value.</p> <p><b>LFSR Status Register [31:16]</b></p>  |



|                  |           |       |       |          | <p>Read Only Value @ Reset: 0x0000</p>   |         |       |       |       |       |            |   |   |   |   |              |   |   |   |   |                 |   |   |   |   |                  |   |   |   |   |              |   |   |   |   |               |   |   |   |   |                 |   |   |   |   |                 |   |   |   |   |               |   |   |   |   |               |   |   |   |   |                 |   |   |   |   |               |   |   |   |   |  |          |  |  |              |   |   |   |           |   |   |   |           |   |   |   |           |   |   |   |           |   |   |   |           |   |   |   |           |   |   |   |           |   |   |   |           |   |   |   |     |           |  |  |  |             |  |  |  |   |   |   |   |   |   |   |   |            |   |   |   |   |   |   |   |   |         |   |   |   |   |   |   |   |   |           |   |   |   |   |   |   |   |   |         |   |   |   |   |   |   |   |   |          |   |   |   |   |   |   |   |   |         |   |   |   |   |   |   |   |   |
|------------------|-----------|-------|-------|----------|--|---------|-------|-------|-------|-------|------------|---|---|---|---|--------------|---|---|---|---|-----------------|---|---|---|---|------------------|---|---|---|---|--------------|---|---|---|---|---------------|---|---|---|---|-----------------|---|---|---|---|-----------------|---|---|---|---|---------------|---|---|---|---|---------------|---|---|---|---|-----------------|---|---|---|---|---------------|---|---|---|---|--|----------|--|--|--------------|---|---|---|-----------|---|---|---|-----------|---|---|---|-----------|---|---|---|-----------|---|---|---|-----------|---|---|---|-----------|---|---|---|-----------|---|---|---|-----------|---|---|---|-----|-----------|--|--|--|-------------|--|--|--|---|---|---|---|---|---|---|---|------------|---|---|---|---|---|---|---|---|---------|---|---|---|---|---|---|---|---|-----------|---|---|---|---|---|---|---|---|---------|---|---|---|---|---|---|---|---|----------|---|---|---|---|---|---|---|---|---------|---|---|---|---|---|---|---|---|
| 0x0008           |           | 32    | I/O   | <b>W</b> | <p><b>RGB Power LED [23:0]</b><br/> <b>B: [7:0]</b><br/> <b>G: [15:8]</b><br/> <b>R: [23:16]</b><br/> <b>Ignored: [31:24]</b><br/>                     The Value of the POWER RGB LED gets refreshed @ every SOF.</p>  |         |       |       |       |       |            |   |   |   |   |              |   |   |   |   |                 |   |   |   |   |                  |   |   |   |   |              |   |   |   |   |               |   |   |   |   |                 |   |   |   |   |                 |   |   |   |   |               |   |   |   |   |               |   |   |   |   |                 |   |   |   |   |               |   |   |   |   |  |          |  |  |              |   |   |   |           |   |   |   |           |   |   |   |           |   |   |   |           |   |   |   |           |   |   |   |           |   |   |   |           |   |   |   |           |   |   |   |     |           |  |  |  |             |  |  |  |   |   |   |   |   |   |   |   |            |   |   |   |   |   |   |   |   |         |   |   |   |   |   |   |   |   |           |   |   |   |   |   |   |   |   |         |   |   |   |   |   |   |   |   |          |   |   |   |   |   |   |   |   |         |   |   |   |   |   |   |   |   |
| 0x000C           |           | 32    | I/O   | <b>R</b> | <p><b>Machine ID [15:0]</b></p> <p>Possible Value for Machine ID:</p> <table border="1"> <thead> <tr> <th>Machine</th> <th>Bit 3</th> <th>Bit 2</th> <th>Bit 1</th> <th>Bit 0</th> </tr> </thead> <tbody> <tr><td><b>FMX</b></td><td>0</td><td>0</td><td>0</td><td>0</td></tr> <tr><td><b>C256U</b></td><td>0</td><td>0</td><td>0</td><td>1</td></tr> <tr><td><b>Reserved</b></td><td>0</td><td>0</td><td>1</td><td>0</td></tr> <tr><td><b>A2560 Dev</b></td><td>0</td><td>0</td><td>1</td><td>1</td></tr> <tr><td><b>GEN X</b></td><td>0</td><td>1</td><td>0</td><td>0</td></tr> <tr><td><b>C256U+</b></td><td>0</td><td>1</td><td>0</td><td>1</td></tr> <tr><td><b>Reserved</b></td><td>0</td><td>1</td><td>1</td><td>0</td></tr> <tr><td><b>Reserved</b></td><td>0</td><td>1</td><td>1</td><td>1</td></tr> <tr><td><b>A2560X</b></td><td>1</td><td>0</td><td>0</td><td>0</td></tr> <tr><td><b>A2560U</b></td><td>1</td><td>0</td><td>0</td><td>1</td></tr> <tr><td><b>Reserved</b></td><td>1</td><td>0</td><td>1</td><td>0</td></tr> <tr><td><b>A2560K</b></td><td>1</td><td>0</td><td>1</td><td>1</td></tr> </tbody> </table> <p>Possible Value for CPU Speed ID:</p> <table border="1"> <thead> <tr> <th></th> <th colspan="3">SPEED ID</th> </tr> <tr> <th>CPU SPEED ID</th> <th>2</th> <th>1</th> <th>0</th> </tr> </thead> <tbody> <tr><td>14.318Mhz</td><td>0</td><td>0</td><td>0</td></tr> <tr><td>20.000Mhz</td><td>0</td><td>0</td><td>1</td></tr> <tr><td>25.000Mhz</td><td>0</td><td>1</td><td>0</td></tr> <tr><td>33.000Mhz</td><td>0</td><td>1</td><td>1</td></tr> <tr><td>40.000Mhz</td><td>1</td><td>0</td><td>0</td></tr> <tr><td>50.000Mhz</td><td>1</td><td>0</td><td>1</td></tr> <tr><td>66.000Mhz</td><td>1</td><td>1</td><td>0</td></tr> <tr><td>80.000Mhz</td><td>1</td><td>1</td><td>1</td></tr> </tbody> </table> <p>Possible Value for CPUID:</p> <table border="1"> <thead> <tr> <th rowspan="2">CPU</th> <th colspan="4">CPU Model</th> <th colspan="4">Speed Grade</th> </tr> <tr> <th>7</th> <th>6</th> <th>5</th> <th>4</th> <th>3</th> <th>2</th> <th>1</th> <th>0</th> </tr> </thead> <tbody> <tr><td>MC68SEC000</td><td>0</td><td>0</td><td>0</td><td>0</td><td>X</td><td>X</td><td>X</td><td>X</td></tr> <tr><td>MC68020</td><td>0</td><td>0</td><td>0</td><td>1</td><td>X</td><td>X</td><td>X</td><td>X</td></tr> <tr><td>MC68EC020</td><td>0</td><td>0</td><td>1</td><td>0</td><td>X</td><td>X</td><td>X</td><td>X</td></tr> <tr><td>MC68030</td><td>0</td><td>0</td><td>1</td><td>1</td><td>X</td><td>X</td><td>X</td><td>X</td></tr> <tr><td>MC68EC30</td><td>0</td><td>1</td><td>0</td><td>0</td><td>X</td><td>X</td><td>X</td><td>X</td></tr> <tr><td>MC68040</td><td>0</td><td>1</td><td>0</td><td>1</td><td>X</td><td>X</td><td>X</td><td>X</td></tr> </tbody> </table> | Machine | Bit 3 | Bit 2 | Bit 1 | Bit 0 | <b>FMX</b> | 0 | 0 | 0 | 0 | <b>C256U</b> | 0 | 0 | 0 | 1 | <b>Reserved</b> | 0 | 0 | 1 | 0 | <b>A2560 Dev</b> | 0 | 0 | 1 | 1 | <b>GEN X</b> | 0 | 1 | 0 | 0 | <b>C256U+</b> | 0 | 1 | 0 | 1 | <b>Reserved</b> | 0 | 1 | 1 | 0 | <b>Reserved</b> | 0 | 1 | 1 | 1 | <b>A2560X</b> | 1 | 0 | 0 | 0 | <b>A2560U</b> | 1 | 0 | 0 | 1 | <b>Reserved</b> | 1 | 0 | 1 | 0 | <b>A2560K</b> | 1 | 0 | 1 | 1 |  | SPEED ID |  |  | CPU SPEED ID | 2 | 1 | 0 | 14.318Mhz | 0 | 0 | 0 | 20.000Mhz | 0 | 0 | 1 | 25.000Mhz | 0 | 1 | 0 | 33.000Mhz | 0 | 1 | 1 | 40.000Mhz | 1 | 0 | 0 | 50.000Mhz | 1 | 0 | 1 | 66.000Mhz | 1 | 1 | 0 | 80.000Mhz | 1 | 1 | 1 | CPU | CPU Model |  |  |  | Speed Grade |  |  |  | 7 | 6 | 5 | 4 | 3 | 2 | 1 | 0 | MC68SEC000 | 0 | 0 | 0 | 0 | X | X | X | X | MC68020 | 0 | 0 | 0 | 1 | X | X | X | X | MC68EC020 | 0 | 0 | 1 | 0 | X | X | X | X | MC68030 | 0 | 0 | 1 | 1 | X | X | X | X | MC68EC30 | 0 | 1 | 0 | 0 | X | X | X | X | MC68040 | 0 | 1 | 0 | 1 | X | X | X | X |
| Machine          | Bit 3     | Bit 2 | Bit 1 | Bit 0    |  |         |       |       |       |       |            |   |   |   |   |              |   |   |   |   |                 |   |   |   |   |                  |   |   |   |   |              |   |   |   |   |               |   |   |   |   |                 |   |   |   |   |                 |   |   |   |   |               |   |   |   |   |               |   |   |   |   |                 |   |   |   |   |               |   |   |   |   |  |          |  |  |              |   |   |   |           |   |   |   |           |   |   |   |           |   |   |   |           |   |   |   |           |   |   |   |           |   |   |   |           |   |   |   |           |   |   |   |     |           |  |  |  |             |  |  |  |   |   |   |   |   |   |   |   |            |   |   |   |   |   |   |   |   |         |   |   |   |   |   |   |   |   |           |   |   |   |   |   |   |   |   |         |   |   |   |   |   |   |   |   |          |   |   |   |   |   |   |   |   |         |   |   |   |   |   |   |   |   |
| <b>FMX</b>       | 0         | 0     | 0     | 0        |  |         |       |       |       |       |            |   |   |   |   |              |   |   |   |   |                 |   |   |   |   |                  |   |   |   |   |              |   |   |   |   |               |   |   |   |   |                 |   |   |   |   |                 |   |   |   |   |               |   |   |   |   |               |   |   |   |   |                 |   |   |   |   |               |   |   |   |   |  |          |  |  |              |   |   |   |           |   |   |   |           |   |   |   |           |   |   |   |           |   |   |   |           |   |   |   |           |   |   |   |           |   |   |   |           |   |   |   |     |           |  |  |  |             |  |  |  |   |   |   |   |   |   |   |   |            |   |   |   |   |   |   |   |   |         |   |   |   |   |   |   |   |   |           |   |   |   |   |   |   |   |   |         |   |   |   |   |   |   |   |   |          |   |   |   |   |   |   |   |   |         |   |   |   |   |   |   |   |   |
| <b>C256U</b>     | 0         | 0     | 0     | 1        |  |         |       |       |       |       |            |   |   |   |   |              |   |   |   |   |                 |   |   |   |   |                  |   |   |   |   |              |   |   |   |   |               |   |   |   |   |                 |   |   |   |   |                 |   |   |   |   |               |   |   |   |   |               |   |   |   |   |                 |   |   |   |   |               |   |   |   |   |  |          |  |  |              |   |   |   |           |   |   |   |           |   |   |   |           |   |   |   |           |   |   |   |           |   |   |   |           |   |   |   |           |   |   |   |           |   |   |   |     |           |  |  |  |             |  |  |  |   |   |   |   |   |   |   |   |            |   |   |   |   |   |   |   |   |         |   |   |   |   |   |   |   |   |           |   |   |   |   |   |   |   |   |         |   |   |   |   |   |   |   |   |          |   |   |   |   |   |   |   |   |         |   |   |   |   |   |   |   |   |
| <b>Reserved</b>  | 0         | 0     | 1     | 0        |  |         |       |       |       |       |            |   |   |   |   |              |   |   |   |   |                 |   |   |   |   |                  |   |   |   |   |              |   |   |   |   |               |   |   |   |   |                 |   |   |   |   |                 |   |   |   |   |               |   |   |   |   |               |   |   |   |   |                 |   |   |   |   |               |   |   |   |   |  |          |  |  |              |   |   |   |           |   |   |   |           |   |   |   |           |   |   |   |           |   |   |   |           |   |   |   |           |   |   |   |           |   |   |   |           |   |   |   |     |           |  |  |  |             |  |  |  |   |   |   |   |   |   |   |   |            |   |   |   |   |   |   |   |   |         |   |   |   |   |   |   |   |   |           |   |   |   |   |   |   |   |   |         |   |   |   |   |   |   |   |   |          |   |   |   |   |   |   |   |   |         |   |   |   |   |   |   |   |   |
| <b>A2560 Dev</b> | 0         | 0     | 1     | 1        |  |         |       |       |       |       |            |   |   |   |   |              |   |   |   |   |                 |   |   |   |   |                  |   |   |   |   |              |   |   |   |   |               |   |   |   |   |                 |   |   |   |   |                 |   |   |   |   |               |   |   |   |   |               |   |   |   |   |                 |   |   |   |   |               |   |   |   |   |  |          |  |  |              |   |   |   |           |   |   |   |           |   |   |   |           |   |   |   |           |   |   |   |           |   |   |   |           |   |   |   |           |   |   |   |           |   |   |   |     |           |  |  |  |             |  |  |  |   |   |   |   |   |   |   |   |            |   |   |   |   |   |   |   |   |         |   |   |   |   |   |   |   |   |           |   |   |   |   |   |   |   |   |         |   |   |   |   |   |   |   |   |          |   |   |   |   |   |   |   |   |         |   |   |   |   |   |   |   |   |
| <b>GEN X</b>     | 0         | 1     | 0     | 0        |  |         |       |       |       |       |            |   |   |   |   |              |   |   |   |   |                 |   |   |   |   |                  |   |   |   |   |              |   |   |   |   |               |   |   |   |   |                 |   |   |   |   |                 |   |   |   |   |               |   |   |   |   |               |   |   |   |   |                 |   |   |   |   |               |   |   |   |   |  |          |  |  |              |   |   |   |           |   |   |   |           |   |   |   |           |   |   |   |           |   |   |   |           |   |   |   |           |   |   |   |           |   |   |   |           |   |   |   |     |           |  |  |  |             |  |  |  |   |   |   |   |   |   |   |   |            |   |   |   |   |   |   |   |   |         |   |   |   |   |   |   |   |   |           |   |   |   |   |   |   |   |   |         |   |   |   |   |   |   |   |   |          |   |   |   |   |   |   |   |   |         |   |   |   |   |   |   |   |   |
| <b>C256U+</b>    | 0         | 1     | 0     | 1        |  |         |       |       |       |       |            |   |   |   |   |              |   |   |   |   |                 |   |   |   |   |                  |   |   |   |   |              |   |   |   |   |               |   |   |   |   |                 |   |   |   |   |                 |   |   |   |   |               |   |   |   |   |               |   |   |   |   |                 |   |   |   |   |               |   |   |   |   |  |          |  |  |              |   |   |   |           |   |   |   |           |   |   |   |           |   |   |   |           |   |   |   |           |   |   |   |           |   |   |   |           |   |   |   |           |   |   |   |     |           |  |  |  |             |  |  |  |   |   |   |   |   |   |   |   |            |   |   |   |   |   |   |   |   |         |   |   |   |   |   |   |   |   |           |   |   |   |   |   |   |   |   |         |   |   |   |   |   |   |   |   |          |   |   |   |   |   |   |   |   |         |   |   |   |   |   |   |   |   |
| <b>Reserved</b>  | 0         | 1     | 1     | 0        |  |         |       |       |       |       |            |   |   |   |   |              |   |   |   |   |                 |   |   |   |   |                  |   |   |   |   |              |   |   |   |   |               |   |   |   |   |                 |   |   |   |   |                 |   |   |   |   |               |   |   |   |   |               |   |   |   |   |                 |   |   |   |   |               |   |   |   |   |  |          |  |  |              |   |   |   |           |   |   |   |           |   |   |   |           |   |   |   |           |   |   |   |           |   |   |   |           |   |   |   |           |   |   |   |           |   |   |   |     |           |  |  |  |             |  |  |  |   |   |   |   |   |   |   |   |            |   |   |   |   |   |   |   |   |         |   |   |   |   |   |   |   |   |           |   |   |   |   |   |   |   |   |         |   |   |   |   |   |   |   |   |          |   |   |   |   |   |   |   |   |         |   |   |   |   |   |   |   |   |
| <b>Reserved</b>  | 0         | 1     | 1     | 1        |  |         |       |       |       |       |            |   |   |   |   |              |   |   |   |   |                 |   |   |   |   |                  |   |   |   |   |              |   |   |   |   |               |   |   |   |   |                 |   |   |   |   |                 |   |   |   |   |               |   |   |   |   |               |   |   |   |   |                 |   |   |   |   |               |   |   |   |   |  |          |  |  |              |   |   |   |           |   |   |   |           |   |   |   |           |   |   |   |           |   |   |   |           |   |   |   |           |   |   |   |           |   |   |   |           |   |   |   |     |           |  |  |  |             |  |  |  |   |   |   |   |   |   |   |   |            |   |   |   |   |   |   |   |   |         |   |   |   |   |   |   |   |   |           |   |   |   |   |   |   |   |   |         |   |   |   |   |   |   |   |   |          |   |   |   |   |   |   |   |   |         |   |   |   |   |   |   |   |   |
| <b>A2560X</b>    | 1         | 0     | 0     | 0        |  |         |       |       |       |       |            |   |   |   |   |              |   |   |   |   |                 |   |   |   |   |                  |   |   |   |   |              |   |   |   |   |               |   |   |   |   |                 |   |   |   |   |                 |   |   |   |   |               |   |   |   |   |               |   |   |   |   |                 |   |   |   |   |               |   |   |   |   |  |          |  |  |              |   |   |   |           |   |   |   |           |   |   |   |           |   |   |   |           |   |   |   |           |   |   |   |           |   |   |   |           |   |   |   |           |   |   |   |     |           |  |  |  |             |  |  |  |   |   |   |   |   |   |   |   |            |   |   |   |   |   |   |   |   |         |   |   |   |   |   |   |   |   |           |   |   |   |   |   |   |   |   |         |   |   |   |   |   |   |   |   |          |   |   |   |   |   |   |   |   |         |   |   |   |   |   |   |   |   |
| <b>A2560U</b>    | 1         | 0     | 0     | 1        |  |         |       |       |       |       |            |   |   |   |   |              |   |   |   |   |                 |   |   |   |   |                  |   |   |   |   |              |   |   |   |   |               |   |   |   |   |                 |   |   |   |   |                 |   |   |   |   |               |   |   |   |   |               |   |   |   |   |                 |   |   |   |   |               |   |   |   |   |  |          |  |  |              |   |   |   |           |   |   |   |           |   |   |   |           |   |   |   |           |   |   |   |           |   |   |   |           |   |   |   |           |   |   |   |           |   |   |   |     |           |  |  |  |             |  |  |  |   |   |   |   |   |   |   |   |            |   |   |   |   |   |   |   |   |         |   |   |   |   |   |   |   |   |           |   |   |   |   |   |   |   |   |         |   |   |   |   |   |   |   |   |          |   |   |   |   |   |   |   |   |         |   |   |   |   |   |   |   |   |
| <b>Reserved</b>  | 1         | 0     | 1     | 0        |  |         |       |       |       |       |            |   |   |   |   |              |   |   |   |   |                 |   |   |   |   |                  |   |   |   |   |              |   |   |   |   |               |   |   |   |   |                 |   |   |   |   |                 |   |   |   |   |               |   |   |   |   |               |   |   |   |   |                 |   |   |   |   |               |   |   |   |   |  |          |  |  |              |   |   |   |           |   |   |   |           |   |   |   |           |   |   |   |           |   |   |   |           |   |   |   |           |   |   |   |           |   |   |   |           |   |   |   |     |           |  |  |  |             |  |  |  |   |   |   |   |   |   |   |   |            |   |   |   |   |   |   |   |   |         |   |   |   |   |   |   |   |   |           |   |   |   |   |   |   |   |   |         |   |   |   |   |   |   |   |   |          |   |   |   |   |   |   |   |   |         |   |   |   |   |   |   |   |   |
| <b>A2560K</b>    | 1         | 0     | 1     | 1        |  |         |       |       |       |       |            |   |   |   |   |              |   |   |   |   |                 |   |   |   |   |                  |   |   |   |   |              |   |   |   |   |               |   |   |   |   |                 |   |   |   |   |                 |   |   |   |   |               |   |   |   |   |               |   |   |   |   |                 |   |   |   |   |               |   |   |   |   |  |          |  |  |              |   |   |   |           |   |   |   |           |   |   |   |           |   |   |   |           |   |   |   |           |   |   |   |           |   |   |   |           |   |   |   |           |   |   |   |     |           |  |  |  |             |  |  |  |   |   |   |   |   |   |   |   |            |   |   |   |   |   |   |   |   |         |   |   |   |   |   |   |   |   |           |   |   |   |   |   |   |   |   |         |   |   |   |   |   |   |   |   |          |   |   |   |   |   |   |   |   |         |   |   |   |   |   |   |   |   |
|                  | SPEED ID  |       |       |          |  |         |       |       |       |       |            |   |   |   |   |              |   |   |   |   |                 |   |   |   |   |                  |   |   |   |   |              |   |   |   |   |               |   |   |   |   |                 |   |   |   |   |                 |   |   |   |   |               |   |   |   |   |               |   |   |   |   |                 |   |   |   |   |               |   |   |   |   |  |          |  |  |              |   |   |   |           |   |   |   |           |   |   |   |           |   |   |   |           |   |   |   |           |   |   |   |           |   |   |   |           |   |   |   |           |   |   |   |     |           |  |  |  |             |  |  |  |   |   |   |   |   |   |   |   |            |   |   |   |   |   |   |   |   |         |   |   |   |   |   |   |   |   |           |   |   |   |   |   |   |   |   |         |   |   |   |   |   |   |   |   |          |   |   |   |   |   |   |   |   |         |   |   |   |   |   |   |   |   |
| CPU SPEED ID     | 2         | 1     | 0     |          |  |         |       |       |       |       |            |   |   |   |   |              |   |   |   |   |                 |   |   |   |   |                  |   |   |   |   |              |   |   |   |   |               |   |   |   |   |                 |   |   |   |   |                 |   |   |   |   |               |   |   |   |   |               |   |   |   |   |                 |   |   |   |   |               |   |   |   |   |  |          |  |  |              |   |   |   |           |   |   |   |           |   |   |   |           |   |   |   |           |   |   |   |           |   |   |   |           |   |   |   |           |   |   |   |           |   |   |   |     |           |  |  |  |             |  |  |  |   |   |   |   |   |   |   |   |            |   |   |   |   |   |   |   |   |         |   |   |   |   |   |   |   |   |           |   |   |   |   |   |   |   |   |         |   |   |   |   |   |   |   |   |          |   |   |   |   |   |   |   |   |         |   |   |   |   |   |   |   |   |
| 14.318Mhz        | 0         | 0     | 0     |          |  |         |       |       |       |       |            |   |   |   |   |              |   |   |   |   |                 |   |   |   |   |                  |   |   |   |   |              |   |   |   |   |               |   |   |   |   |                 |   |   |   |   |                 |   |   |   |   |               |   |   |   |   |               |   |   |   |   |                 |   |   |   |   |               |   |   |   |   |  |          |  |  |              |   |   |   |           |   |   |   |           |   |   |   |           |   |   |   |           |   |   |   |           |   |   |   |           |   |   |   |           |   |   |   |           |   |   |   |     |           |  |  |  |             |  |  |  |   |   |   |   |   |   |   |   |            |   |   |   |   |   |   |   |   |         |   |   |   |   |   |   |   |   |           |   |   |   |   |   |   |   |   |         |   |   |   |   |   |   |   |   |          |   |   |   |   |   |   |   |   |         |   |   |   |   |   |   |   |   |
| 20.000Mhz        | 0         | 0     | 1     |          |  |         |       |       |       |       |            |   |   |   |   |              |   |   |   |   |                 |   |   |   |   |                  |   |   |   |   |              |   |   |   |   |               |   |   |   |   |                 |   |   |   |   |                 |   |   |   |   |               |   |   |   |   |               |   |   |   |   |                 |   |   |   |   |               |   |   |   |   |  |          |  |  |              |   |   |   |           |   |   |   |           |   |   |   |           |   |   |   |           |   |   |   |           |   |   |   |           |   |   |   |           |   |   |   |           |   |   |   |     |           |  |  |  |             |  |  |  |   |   |   |   |   |   |   |   |            |   |   |   |   |   |   |   |   |         |   |   |   |   |   |   |   |   |           |   |   |   |   |   |   |   |   |         |   |   |   |   |   |   |   |   |          |   |   |   |   |   |   |   |   |         |   |   |   |   |   |   |   |   |
| 25.000Mhz        | 0         | 1     | 0     |          |  |         |       |       |       |       |            |   |   |   |   |              |   |   |   |   |                 |   |   |   |   |                  |   |   |   |   |              |   |   |   |   |               |   |   |   |   |                 |   |   |   |   |                 |   |   |   |   |               |   |   |   |   |               |   |   |   |   |                 |   |   |   |   |               |   |   |   |   |  |          |  |  |              |   |   |   |           |   |   |   |           |   |   |   |           |   |   |   |           |   |   |   |           |   |   |   |           |   |   |   |           |   |   |   |           |   |   |   |     |           |  |  |  |             |  |  |  |   |   |   |   |   |   |   |   |            |   |   |   |   |   |   |   |   |         |   |   |   |   |   |   |   |   |           |   |   |   |   |   |   |   |   |         |   |   |   |   |   |   |   |   |          |   |   |   |   |   |   |   |   |         |   |   |   |   |   |   |   |   |
| 33.000Mhz        | 0         | 1     | 1     |          |  |         |       |       |       |       |            |   |   |   |   |              |   |   |   |   |                 |   |   |   |   |                  |   |   |   |   |              |   |   |   |   |               |   |   |   |   |                 |   |   |   |   |                 |   |   |   |   |               |   |   |   |   |               |   |   |   |   |                 |   |   |   |   |               |   |   |   |   |  |          |  |  |              |   |   |   |           |   |   |   |           |   |   |   |           |   |   |   |           |   |   |   |           |   |   |   |           |   |   |   |           |   |   |   |           |   |   |   |     |           |  |  |  |             |  |  |  |   |   |   |   |   |   |   |   |            |   |   |   |   |   |   |   |   |         |   |   |   |   |   |   |   |   |           |   |   |   |   |   |   |   |   |         |   |   |   |   |   |   |   |   |          |   |   |   |   |   |   |   |   |         |   |   |   |   |   |   |   |   |
| 40.000Mhz        | 1         | 0     | 0     |          |  |         |       |       |       |       |            |   |   |   |   |              |   |   |   |   |                 |   |   |   |   |                  |   |   |   |   |              |   |   |   |   |               |   |   |   |   |                 |   |   |   |   |                 |   |   |   |   |               |   |   |   |   |               |   |   |   |   |                 |   |   |   |   |               |   |   |   |   |  |          |  |  |              |   |   |   |           |   |   |   |           |   |   |   |           |   |   |   |           |   |   |   |           |   |   |   |           |   |   |   |           |   |   |   |           |   |   |   |     |           |  |  |  |             |  |  |  |   |   |   |   |   |   |   |   |            |   |   |   |   |   |   |   |   |         |   |   |   |   |   |   |   |   |           |   |   |   |   |   |   |   |   |         |   |   |   |   |   |   |   |   |          |   |   |   |   |   |   |   |   |         |   |   |   |   |   |   |   |   |
| 50.000Mhz        | 1         | 0     | 1     |          |  |         |       |       |       |       |            |   |   |   |   |              |   |   |   |   |                 |   |   |   |   |                  |   |   |   |   |              |   |   |   |   |               |   |   |   |   |                 |   |   |   |   |                 |   |   |   |   |               |   |   |   |   |               |   |   |   |   |                 |   |   |   |   |               |   |   |   |   |  |          |  |  |              |   |   |   |           |   |   |   |           |   |   |   |           |   |   |   |           |   |   |   |           |   |   |   |           |   |   |   |           |   |   |   |           |   |   |   |     |           |  |  |  |             |  |  |  |   |   |   |   |   |   |   |   |            |   |   |   |   |   |   |   |   |         |   |   |   |   |   |   |   |   |           |   |   |   |   |   |   |   |   |         |   |   |   |   |   |   |   |   |          |   |   |   |   |   |   |   |   |         |   |   |   |   |   |   |   |   |
| 66.000Mhz        | 1         | 1     | 0     |          |  |         |       |       |       |       |            |   |   |   |   |              |   |   |   |   |                 |   |   |   |   |                  |   |   |   |   |              |   |   |   |   |               |   |   |   |   |                 |   |   |   |   |                 |   |   |   |   |               |   |   |   |   |               |   |   |   |   |                 |   |   |   |   |               |   |   |   |   |  |          |  |  |              |   |   |   |           |   |   |   |           |   |   |   |           |   |   |   |           |   |   |   |           |   |   |   |           |   |   |   |           |   |   |   |           |   |   |   |     |           |  |  |  |             |  |  |  |   |   |   |   |   |   |   |   |            |   |   |   |   |   |   |   |   |         |   |   |   |   |   |   |   |   |           |   |   |   |   |   |   |   |   |         |   |   |   |   |   |   |   |   |          |   |   |   |   |   |   |   |   |         |   |   |   |   |   |   |   |   |
| 80.000Mhz        | 1         | 1     | 1     |          |  |         |       |       |       |       |            |   |   |   |   |              |   |   |   |   |                 |   |   |   |   |                  |   |   |   |   |              |   |   |   |   |               |   |   |   |   |                 |   |   |   |   |                 |   |   |   |   |               |   |   |   |   |               |   |   |   |   |                 |   |   |   |   |               |   |   |   |   |  |          |  |  |              |   |   |   |           |   |   |   |           |   |   |   |           |   |   |   |           |   |   |   |           |   |   |   |           |   |   |   |           |   |   |   |           |   |   |   |     |           |  |  |  |             |  |  |  |   |   |   |   |   |   |   |   |            |   |   |   |   |   |   |   |   |         |   |   |   |   |   |   |   |   |           |   |   |   |   |   |   |   |   |         |   |   |   |   |   |   |   |   |          |   |   |   |   |   |   |   |   |         |   |   |   |   |   |   |   |   |
| CPU              | CPU Model |       |       |          | Speed Grade  |         |       |       |       |       |            |   |   |   |   |              |   |   |   |   |                 |   |   |   |   |                  |   |   |   |   |              |   |   |   |   |               |   |   |   |   |                 |   |   |   |   |                 |   |   |   |   |               |   |   |   |   |               |   |   |   |   |                 |   |   |   |   |               |   |   |   |   |  |          |  |  |              |   |   |   |           |   |   |   |           |   |   |   |           |   |   |   |           |   |   |   |           |   |   |   |           |   |   |   |           |   |   |   |           |   |   |   |     |           |  |  |  |             |  |  |  |   |   |   |   |   |   |   |   |            |   |   |   |   |   |   |   |   |         |   |   |   |   |   |   |   |   |           |   |   |   |   |   |   |   |   |         |   |   |   |   |   |   |   |   |          |   |   |   |   |   |   |   |   |         |   |   |   |   |   |   |   |   |
|                  | 7         | 6     | 5     | 4        | 3  | 2       | 1     | 0     |       |       |            |   |   |   |   |              |   |   |   |   |                 |   |   |   |   |                  |   |   |   |   |              |   |   |   |   |               |   |   |   |   |                 |   |   |   |   |                 |   |   |   |   |               |   |   |   |   |               |   |   |   |   |                 |   |   |   |   |               |   |   |   |   |  |          |  |  |              |   |   |   |           |   |   |   |           |   |   |   |           |   |   |   |           |   |   |   |           |   |   |   |           |   |   |   |           |   |   |   |           |   |   |   |     |           |  |  |  |             |  |  |  |   |   |   |   |   |   |   |   |            |   |   |   |   |   |   |   |   |         |   |   |   |   |   |   |   |   |           |   |   |   |   |   |   |   |   |         |   |   |   |   |   |   |   |   |          |   |   |   |   |   |   |   |   |         |   |   |   |   |   |   |   |   |
| MC68SEC000       | 0         | 0     | 0     | 0        | X  | X       | X     | X     |       |       |            |   |   |   |   |              |   |   |   |   |                 |   |   |   |   |                  |   |   |   |   |              |   |   |   |   |               |   |   |   |   |                 |   |   |   |   |                 |   |   |   |   |               |   |   |   |   |               |   |   |   |   |                 |   |   |   |   |               |   |   |   |   |  |          |  |  |              |   |   |   |           |   |   |   |           |   |   |   |           |   |   |   |           |   |   |   |           |   |   |   |           |   |   |   |           |   |   |   |           |   |   |   |     |           |  |  |  |             |  |  |  |   |   |   |   |   |   |   |   |            |   |   |   |   |   |   |   |   |         |   |   |   |   |   |   |   |   |           |   |   |   |   |   |   |   |   |         |   |   |   |   |   |   |   |   |          |   |   |   |   |   |   |   |   |         |   |   |   |   |   |   |   |   |
| MC68020          | 0         | 0     | 0     | 1        | X  | X       | X     | X     |       |       |            |   |   |   |   |              |   |   |   |   |                 |   |   |   |   |                  |   |   |   |   |              |   |   |   |   |               |   |   |   |   |                 |   |   |   |   |                 |   |   |   |   |               |   |   |   |   |               |   |   |   |   |                 |   |   |   |   |               |   |   |   |   |  |          |  |  |              |   |   |   |           |   |   |   |           |   |   |   |           |   |   |   |           |   |   |   |           |   |   |   |           |   |   |   |           |   |   |   |           |   |   |   |     |           |  |  |  |             |  |  |  |   |   |   |   |   |   |   |   |            |   |   |   |   |   |   |   |   |         |   |   |   |   |   |   |   |   |           |   |   |   |   |   |   |   |   |         |   |   |   |   |   |   |   |   |          |   |   |   |   |   |   |   |   |         |   |   |   |   |   |   |   |   |
| MC68EC020        | 0         | 0     | 1     | 0        | X  | X       | X     | X     |       |       |            |   |   |   |   |              |   |   |   |   |                 |   |   |   |   |                  |   |   |   |   |              |   |   |   |   |               |   |   |   |   |                 |   |   |   |   |                 |   |   |   |   |               |   |   |   |   |               |   |   |   |   |                 |   |   |   |   |               |   |   |   |   |  |          |  |  |              |   |   |   |           |   |   |   |           |   |   |   |           |   |   |   |           |   |   |   |           |   |   |   |           |   |   |   |           |   |   |   |           |   |   |   |     |           |  |  |  |             |  |  |  |   |   |   |   |   |   |   |   |            |   |   |   |   |   |   |   |   |         |   |   |   |   |   |   |   |   |           |   |   |   |   |   |   |   |   |         |   |   |   |   |   |   |   |   |          |   |   |   |   |   |   |   |   |         |   |   |   |   |   |   |   |   |
| MC68030          | 0         | 0     | 1     | 1        | X  | X       | X     | X     |       |       |            |   |   |   |   |              |   |   |   |   |                 |   |   |   |   |                  |   |   |   |   |              |   |   |   |   |               |   |   |   |   |                 |   |   |   |   |                 |   |   |   |   |               |   |   |   |   |               |   |   |   |   |                 |   |   |   |   |               |   |   |   |   |  |          |  |  |              |   |   |   |           |   |   |   |           |   |   |   |           |   |   |   |           |   |   |   |           |   |   |   |           |   |   |   |           |   |   |   |           |   |   |   |     |           |  |  |  |             |  |  |  |   |   |   |   |   |   |   |   |            |   |   |   |   |   |   |   |   |         |   |   |   |   |   |   |   |   |           |   |   |   |   |   |   |   |   |         |   |   |   |   |   |   |   |   |          |   |   |   |   |   |   |   |   |         |   |   |   |   |   |   |   |   |
| MC68EC30         | 0         | 1     | 0     | 0        | X  | X       | X     | X     |       |       |            |   |   |   |   |              |   |   |   |   |                 |   |   |   |   |                  |   |   |   |   |              |   |   |   |   |               |   |   |   |   |                 |   |   |   |   |                 |   |   |   |   |               |   |   |   |   |               |   |   |   |   |                 |   |   |   |   |               |   |   |   |   |  |          |  |  |              |   |   |   |           |   |   |   |           |   |   |   |           |   |   |   |           |   |   |   |           |   |   |   |           |   |   |   |           |   |   |   |           |   |   |   |     |           |  |  |  |             |  |  |  |   |   |   |   |   |   |   |   |            |   |   |   |   |   |   |   |   |         |   |   |   |   |   |   |   |   |           |   |   |   |   |   |   |   |   |         |   |   |   |   |   |   |   |   |          |   |   |   |   |   |   |   |   |         |   |   |   |   |   |   |   |   |
| MC68040          | 0         | 1     | 0     | 1        | X  | X       | X     | X     |       |       |            |   |   |   |   |              |   |   |   |   |                 |   |   |   |   |                  |   |   |   |   |              |   |   |   |   |               |   |   |   |   |                 |   |   |   |   |                 |   |   |   |   |               |   |   |   |   |               |   |   |   |   |                 |   |   |   |   |               |   |   |   |   |  |          |  |  |              |   |   |   |           |   |   |   |           |   |   |   |           |   |   |   |           |   |   |   |           |   |   |   |           |   |   |   |           |   |   |   |           |   |   |   |     |           |  |  |  |             |  |  |  |   |   |   |   |   |   |   |   |            |   |   |   |   |   |   |   |   |         |   |   |   |   |   |   |   |   |           |   |   |   |   |   |   |   |   |         |   |   |   |   |   |   |   |   |          |   |   |   |   |   |   |   |   |         |   |   |   |   |   |   |   |   |

# A2560 FOENIX K - User Manual

|               |   |           |            |          |   |          |   |   |   |   |   |   |   |   |          |   |   |   |   |   |   |   |   |           |   |   |   |   |   |   |   |   |           |   |   |   |   |   |   |   |   |        |   |   |   |   |   |   |   |   |
|---------------|---|-----------|------------|----------|---|----------|---|---|---|---|---|---|---|---|----------|---|---|---|---|---|---|---|---|-----------|---|---|---|---|---|---|---|---|-----------|---|---|---|---|---|---|---|---|--------|---|---|---|---|---|---|---|---|
|               |   |           |            |          | <table border="1"> <tr> <td>MC68040V</td> <td>0</td> <td>1</td> <td>1</td> <td>0</td> <td>X</td> <td>X</td> <td>X</td> <td>X</td> </tr> <tr> <td>MC68EC40</td> <td>0</td> <td>1</td> <td>1</td> <td>1</td> <td>X</td> <td>X</td> <td>X</td> <td>X</td> </tr> <tr> <td>486DX2-50</td> <td>1</td> <td>0</td> <td>0</td> <td>0</td> <td>0</td> <td>0</td> <td>0</td> <td>0</td> </tr> <tr> <td>486DX2-66</td> <td>1</td> <td>0</td> <td>0</td> <td>0</td> <td>0</td> <td>0</td> <td>0</td> <td>1</td> </tr> <tr> <td>486DX4</td> <td>1</td> <td>0</td> <td>0</td> <td>1</td> <td>X</td> <td>X</td> <td>X</td> <td>X</td> </tr> </table> <p><b>Chip Subversion [31:16] – In Hex</b></p> | MC68040V | 0 | 1 | 1 | 0 | X | X | X | X | MC68EC40 | 0 | 1 | 1 | 1 | X | X | X | X | 486DX2-50 | 1 | 0 | 0 | 0 | 0 | 0 | 0 | 0 | 486DX2-66 | 1 | 0 | 0 | 0 | 0 | 0 | 0 | 1 | 486DX4 | 1 | 0 | 0 | 1 | X | X | X | X |
| MC68040V      | 0 | 1         | 1          | 0        | X   | X        | X | X |   |   |   |   |   |   |          |   |   |   |   |   |   |   |   |           |   |   |   |   |   |   |   |   |           |   |   |   |   |   |   |   |   |        |   |   |   |   |   |   |   |   |
| MC68EC40      | 0 | 1         | 1          | 1        | X   | X        | X | X |   |   |   |   |   |   |          |   |   |   |   |   |   |   |   |           |   |   |   |   |   |   |   |   |           |   |   |   |   |   |   |   |   |        |   |   |   |   |   |   |   |   |
| 486DX2-50     | 1 | 0         | 0          | 0        | 0   | 0        | 0 | 0 |   |   |   |   |   |   |          |   |   |   |   |   |   |   |   |           |   |   |   |   |   |   |   |   |           |   |   |   |   |   |   |   |   |        |   |   |   |   |   |   |   |   |
| 486DX2-66     | 1 | 0         | 0          | 0        | 0   | 0        | 0 | 1 |   |   |   |   |   |   |          |   |   |   |   |   |   |   |   |           |   |   |   |   |   |   |   |   |           |   |   |   |   |   |   |   |   |        |   |   |   |   |   |   |   |   |
| 486DX4        | 1 | 0         | 0          | 1        | X   | X        | X | X |   |   |   |   |   |   |          |   |   |   |   |   |   |   |   |           |   |   |   |   |   |   |   |   |           |   |   |   |   |   |   |   |   |        |   |   |   |   |   |   |   |   |
| <b>0x000C</b> |   | <b>32</b> | <b>I/O</b> | <b>W</b> | <p><b>A2560K (Mau's) Keyboard – Status LED</b><br/> <b>Top Right: bit [2:0] - RGB</b><br/> <b>Middle Right: [5:3] - RGB</b><br/> <b>Bottom Right: [8:6] – RGB</b><br/> <b>Middle Left: (Caps Lock) [11:9] – RGB</b><br/>                     The Value of the status led are simply on or off, so only 7 colors (the basic colors) can be programmed.</p>   |          |   |   |   |   |   |   |   |   |          |   |   |   |   |   |   |   |   |           |   |   |   |   |   |   |   |   |           |   |   |   |   |   |   |   |   |        |   |   |   |   |   |   |   |   |
| <b>0x0010</b> |   | <b>32</b> | <b>I/O</b> | <b>R</b> | <p><b>Chip Version [15:0] – In Hex</b><br/> <b>Chip Number [15:0] – In Hex</b></p>  |          |   |   |   |   |   |   |   |   |          |   |   |   |   |   |   |   |   |           |   |   |   |   |   |   |   |   |           |   |   |   |   |   |   |   |   |        |   |   |   |   |   |   |   |   |
| <b>0x0014</b> |   | <b>32</b> | <b>I/O</b> | <b>R</b> | <p><b>FIRMWARE DATE:</b><br/> <b>YEAR: [7:0] – Value in Decimal</b><br/> <b>MONTH: [15:8] – Value in Decimal</b><br/> <b>DAY: [23:16] – Value in Decimal</b><br/> <b>Reserved: [31:24] = 8'h00</b></p>  |          |   |   |   |   |   |   |   |   |          |   |   |   |   |   |   |   |   |           |   |   |   |   |   |   |   |   |           |   |   |   |   |   |   |   |   |        |   |   |   |   |   |   |   |   |
| <b>0x0018</b> |   | <b>32</b> | <b>I/O</b> | <b>R</b> | <p><b>HARDWARE (PCB) DATE: (Rev A0B) right now</b><br/> <b>EOS: [7:0] - \$00</b><br/> <b>REV DIGIT2: [15:8] – \$42 - Value in ASCII</b><br/> <b>REV DIGIT1: [23:16] – \$30 – Value in ASCII</b><br/> <b>REV DIGIT0: [31:24] = \$41 – Value in ASCII</b></p>   |          |   |   |   |   |   |   |   |   |          |   |   |   |   |   |   |   |   |           |   |   |   |   |   |   |   |   |           |   |   |   |   |   |   |   |   |        |   |   |   |   |   |   |   |   |
| <b>0x001C</b> |   | <b>16</b> | <b>I/O</b> | <b>R</b> | <p><b>HARDWARE (PCB) DATE:</b><br/> <b>YEAR: [7:0] – Value in Decimal</b><br/> <b>MONTH: [15:8] – Value in Decimal</b><br/> <b>DAY: [23:16] – Value in Decimal</b><br/> <b>Reserved: [31:24] = 8'h00</b></p>  |          |   |   |   |   |   |   |   |   |          |   |   |   |   |   |   |   |   |           |   |   |   |   |   |   |   |   |           |   |   |   |   |   |   |   |   |        |   |   |   |   |   |   |   |   |

## 9.1.2. A2560K - (Mau's) Keyboard register

| Addy Start Offset | Addy End | Size      | Type       | R/W      | Description   |
|-------------------|----------|-----------|------------|----------|---|
| <b>0x0040</b>     |          | <b>32</b> | <b>I/O</b> | <b>R</b> | <p><b>Keyboard Input Register</b></p> <p>                     7 6 5 4 3 2 1 0<br/>                     FIFO Out Keyboard Keycode[7] → FIFO Out Keyboard Keycode[0]<br/>                     FIFO Out Keyboard Keycode[6] → FIFO Out Keyboard Keycode[1]<br/>                     FIFO Out Keyboard Keycode[5] → FIFO Out Keyboard Keycode[2]<br/>                     FIFO Out Keyboard Keycode[4] → FIFO Out Keyboard Keycode[3]                 </p> <p>                     15 14 13 12 11 10 9 8<br/>                     FIFO Out Keyboard Keycode[15] → FIFO Out Keyboard Keycode[8]<br/>                     FIFO Out Keyboard Keycode[14] → FIFO Out Keyboard Keycode[9]<br/>                     FIFO Out Keyboard Keycode[13] → FIFO Out Keyboard Keycode[10]<br/>                     FIFO Out Keyboard Keycode[12] → FIFO Out Keyboard Keycode[11]                 </p> <p>                     23 22 21 20 19 18 17 16<br/>                     FIFO Used DW[7] → FIFO Used DW[0]<br/>                     FIFO Used DW[6] → FIFO Used DW[1]<br/>                     FIFO Used DW[5] → FIFO Used DW[2]<br/>                     FIFO Used DW[4] → FIFO Used DW[3]                 </p> <p>                     31 30 29 28 27 26 25 24<br/>                     (1 = Empty) FIFO Empty Flag → Reserved<br/>                     (1 = Full) FIFO Full Flag → Reserved<br/>                     Reserved → Reserved<br/>                     Reserved → Reserved                 </p> |
| <b>0x0040</b>     |          | <b>32</b> | <b>I/O</b> | <b>R</b> | <p><b>Dummy Register</b><br/>                     Return Value : 0x0001_0000</p>  |

9.1.3. Real Time Clock

(For Detailed information, please consult the BQ4802LY Datasheet)

| Addy Start Offset                  | Addy End      | Size | Type | R/W | Description  |   |   |   |   |   |   |   |   |   |                                    |               |      |   |   |   |   |   |   |               |  |   |   |   |   |   |   |   |
|------------------------------------|---------------|------|------|-----|--|---|---|---|---|---|---|---|---|---|------------------------------------|---------------|------|---|---|---|---|---|---|---------------|--|---|---|---|---|---|---|---|
| 0x0080                             |               | 8    | I/O  | R/W | <b>RTC – Seconds Register</b><br><table border="1"> <thead> <tr> <th></th> <th>7</th> <th>6</th> <th>5</th> <th>4</th> <th>3</th> <th>2</th> <th>1</th> <th>0</th> </tr> </thead> <tbody> <tr> <td>Seconds (00-59)</td> <td>0</td> <td>T</td> <td>T</td> <td>T</td> <td>U</td> <td>U</td> <td>U</td> <td>U</td> </tr> </tbody> </table> <p>- T = Tens, U = Units</p>   |   | 7 | 6 | 5 | 4 | 3 | 2 | 1 | 0 | Seconds (00-59)                    | 0             | T    | T | T | U | U | U | U |               |  |   |   |   |   |   |   |   |
|                                    | 7             | 6    | 5    | 4   | 3  | 2 | 1 | 0 |   |   |   |   |   |   |                                    |               |      |   |   |   |   |   |   |               |  |   |   |   |   |   |   |   |
| Seconds (00-59)                    | 0             | T    | T    | T   | U  | U | U | U |   |   |   |   |   |   |                                    |               |      |   |   |   |   |   |   |               |  |   |   |   |   |   |   |   |
| 0x0081                             |               | 8    | I/O  | R/W | <b>RTC – Seconds Alarm</b><br><table border="1"> <thead> <tr> <th></th> <th>7</th> <th>6</th> <th>5</th> <th>4</th> <th>3</th> <th>2</th> <th>1</th> <th>0</th> </tr> </thead> <tbody> <tr> <td>Seconds alarm</td> <td>ALM1</td> <td>ALM0</td> <td>T</td> <td>T</td> <td>U</td> <td>U</td> <td>U</td> <td>U</td> </tr> <tr> <td>Seconds alarm</td> <td></td> <td>T</td> <td>T</td> <td>T</td> <td>U</td> <td>U</td> <td>U</td> <td>U</td> </tr> </tbody> </table> <p>- T = Tens, U = Units</p> |   | 7 | 6 | 5 | 4 | 3 | 2 | 1 | 0 | Seconds alarm                      | ALM1          | ALM0 | T | T | U | U | U | U | Seconds alarm |  | T | T | T | U | U | U | U |
|                                    | 7             | 6    | 5    | 4   | 3  | 2 | 1 | 0 |   |   |   |   |   |   |                                    |               |      |   |   |   |   |   |   |               |  |   |   |   |   |   |   |   |
| Seconds alarm                      | ALM1          | ALM0 | T    | T   | U  | U | U | U |   |   |   |   |   |   |                                    |               |      |   |   |   |   |   |   |               |  |   |   |   |   |   |   |   |
| Seconds alarm                      |               | T    | T    | T   | U  | U | U | U |   |   |   |   |   |   |                                    |               |      |   |   |   |   |   |   |               |  |   |   |   |   |   |   |   |
| 0x0082                             |               | 8    | I/O  | R/W | <b>RTC – Minutes Register</b><br><table border="1"> <thead> <tr> <th></th> <th>7</th> <th>6</th> <th>5</th> <th>4</th> <th>3</th> <th>2</th> <th>1</th> <th>0</th> </tr> </thead> <tbody> <tr> <td>Minutes (00-59)</td> <td>0</td> <td>T</td> <td>T</td> <td>T</td> <td>U</td> <td>U</td> <td>U</td> <td>U</td> </tr> </tbody> </table> <p>- T = Tens, U = Units</p>   |   | 7 | 6 | 5 | 4 | 3 | 2 | 1 | 0 | Minutes (00-59)                    | 0             | T    | T | T | U | U | U | U |               |  |   |   |   |   |   |   |   |
|                                    | 7             | 6    | 5    | 4   | 3  | 2 | 1 | 0 |   |   |   |   |   |   |                                    |               |      |   |   |   |   |   |   |               |  |   |   |   |   |   |   |   |
| Minutes (00-59)                    | 0             | T    | T    | T   | U  | U | U | U |   |   |   |   |   |   |                                    |               |      |   |   |   |   |   |   |               |  |   |   |   |   |   |   |   |
| 0x0083                             |               | 8    | I/O  | R/W | <b>RTC – Minutes Alarm</b><br><table border="1"> <thead> <tr> <th></th> <th>7</th> <th>6</th> <th>5</th> <th>4</th> <th>3</th> <th>2</th> <th>1</th> <th>0</th> </tr> </thead> <tbody> <tr> <td>Minutes alarm</td> <td>ALM1</td> <td>ALM0</td> <td>T</td> <td>T</td> <td>U</td> <td>U</td> <td>U</td> <td>U</td> </tr> <tr> <td>Minutes alarm</td> <td></td> <td>T</td> <td>T</td> <td>T</td> <td>U</td> <td>U</td> <td>U</td> <td>U</td> </tr> </tbody> </table> <p>- T = Tens, U = Units</p> |   | 7 | 6 | 5 | 4 | 3 | 2 | 1 | 0 | Minutes alarm                      | ALM1          | ALM0 | T | T | U | U | U | U | Minutes alarm |  | T | T | T | U | U | U | U |
|                                    | 7             | 6    | 5    | 4   | 3  | 2 | 1 | 0 |   |   |   |   |   |   |                                    |               |      |   |   |   |   |   |   |               |  |   |   |   |   |   |   |   |
| Minutes alarm                      | ALM1          | ALM0 | T    | T   | U  | U | U | U |   |   |   |   |   |   |                                    |               |      |   |   |   |   |   |   |               |  |   |   |   |   |   |   |   |
| Minutes alarm                      |               | T    | T    | T   | U  | U | U | U |   |   |   |   |   |   |                                    |               |      |   |   |   |   |   |   |               |  |   |   |   |   |   |   |   |
| 0x0084                             |               | 8    | I/O  | R/W | <b>RTC – Hours Register</b><br><table border="1"> <thead> <tr> <th></th> <th>7</th> <th>6</th> <th>5</th> <th>4</th> <th>3</th> <th>2</th> <th>1</th> <th>0</th> </tr> </thead> <tbody> <tr> <td>Hours (01-12AM)<br/>Hours (81-92PM)</td> <td>PM/AM</td> <td>0</td> <td>T</td> <td>T</td> <td>U</td> <td>U</td> <td>U</td> <td>U</td> </tr> </tbody> </table> <p>- T = Tens, U = Units</p>   |   | 7 | 6 | 5 | 4 | 3 | 2 | 1 | 0 | Hours (01-12AM)<br>Hours (81-92PM) | PM/AM         | 0    | T | T | U | U | U | U |               |  |   |   |   |   |   |   |   |
|                                    | 7             | 6    | 5    | 4   | 3  | 2 | 1 | 0 |   |   |   |   |   |   |                                    |               |      |   |   |   |   |   |   |               |  |   |   |   |   |   |   |   |
| Hours (01-12AM)<br>Hours (81-92PM) | PM/AM         | 0    | T    | T   | U  | U | U | U |   |   |   |   |   |   |                                    |               |      |   |   |   |   |   |   |               |  |   |   |   |   |   |   |   |
| 0x0085                             |               | 8    | I/O  | R/W | <b>RTC – Hours Alarm</b><br><table border="1"> <thead> <tr> <th></th> <th>7</th> <th>6</th> <th>5</th> <th>4</th> <th>3</th> <th>2</th> <th>1</th> <th>0</th> </tr> </thead> <tbody> <tr> <td>Hours (01-12AM)<br/>Hours (81-92PM)</td> <td>PM/AM<br/>ALM1</td> <td>ALM0</td> <td>T</td> <td>T</td> <td>U</td> <td>U</td> <td>U</td> <td>U</td> </tr> </tbody> </table> <p>- T = Tens, U = Units</p>  |   | 7 | 6 | 5 | 4 | 3 | 2 | 1 | 0 | Hours (01-12AM)<br>Hours (81-92PM) | PM/AM<br>ALM1 | ALM0 | T | T | U | U | U | U |               |  |   |   |   |   |   |   |   |
|                                    | 7             | 6    | 5    | 4   | 3  | 2 | 1 | 0 |   |   |   |   |   |   |                                    |               |      |   |   |   |   |   |   |               |  |   |   |   |   |   |   |   |
| Hours (01-12AM)<br>Hours (81-92PM) | PM/AM<br>ALM1 | ALM0 | T    | T   | U  | U | U | U |   |   |   |   |   |   |                                    |               |      |   |   |   |   |   |   |               |  |   |   |   |   |   |   |   |
| 0x0086                             |               | 8    | I/O  | R/W | <b>RTC – Day</b><br><table border="1"> <thead> <tr> <th></th> <th>7</th> <th>6</th> <th>5</th> <th>4</th> <th>3</th> <th>2</th> <th>1</th> <th>0</th> </tr> </thead> <tbody> <tr> <td>Day (01-31)</td> <td>0</td> <td>0</td> <td>T</td> <td>T</td> <td>U</td> <td>U</td> <td>U</td> <td>U</td> </tr> </tbody> </table> <p>- T = Tens, U = Units</p>  |   | 7 | 6 | 5 | 4 | 3 | 2 | 1 | 0 | Day (01-31)                        | 0             | 0    | T | T | U | U | U | U |               |  |   |   |   |   |   |   |   |
|                                    | 7             | 6    | 5    | 4   | 3  | 2 | 1 | 0 |   |   |   |   |   |   |                                    |               |      |   |   |   |   |   |   |               |  |   |   |   |   |   |   |   |
| Day (01-31)                        | 0             | 0    | T    | T   | U  | U | U | U |   |   |   |   |   |   |                                    |               |      |   |   |   |   |   |   |               |  |   |   |   |   |   |   |   |
| 0x0087                             |               | 8    | I/O  | R/W | <b>RTC – Day Alarm</b><br><table border="1"> <thead> <tr> <th></th> <th>7</th> <th>6</th> <th>5</th> <th>4</th> <th>3</th> <th>2</th> <th>1</th> <th>0</th> </tr> </thead> <tbody> <tr> <td>Day (01-31)</td> <td>ALM1</td> <td>ALM0</td> <td>T</td> <td>T</td> <td>U</td> <td>U</td> <td>U</td> <td>U</td> </tr> </tbody> </table> <p>- T = Tens, U = Units</p>  |   | 7 | 6 | 5 | 4 | 3 | 2 | 1 | 0 | Day (01-31)                        | ALM1          | ALM0 | T | T | U | U | U | U |               |  |   |   |   |   |   |   |   |
|                                    | 7             | 6    | 5    | 4   | 3  | 2 | 1 | 0 |   |   |   |   |   |   |                                    |               |      |   |   |   |   |   |   |               |  |   |   |   |   |   |   |   |
| Day (01-31)                        | ALM1          | ALM0 | T    | T   | U  | U | U | U |   |   |   |   |   |   |                                    |               |      |   |   |   |   |   |   |               |  |   |   |   |   |   |   |   |
| 0x0088                             |               | 8    | I/O  | R/W | <b>RTC – Day of Week</b><br><table border="1"> <thead> <tr> <th></th> <th>7</th> <th>6</th> <th>5</th> <th>4</th> <th>3</th> <th>2</th> <th>1</th> <th>0</th> </tr> </thead> <tbody> <tr> <td>Day of Week (01-07)</td> <td>0</td> <td>0</td> <td>0</td> <td>0</td> <td>0</td> <td>U</td> <td>U</td> <td>U</td> </tr> </tbody> </table> <p>- U = Units</p>  |   | 7 | 6 | 5 | 4 | 3 | 2 | 1 | 0 | Day of Week (01-07)                | 0             | 0    | 0 | 0 | 0 | U | U | U |               |  |   |   |   |   |   |   |   |
|                                    | 7             | 6    | 5    | 4   | 3  | 2 | 1 | 0 |   |   |   |   |   |   |                                    |               |      |   |   |   |   |   |   |               |  |   |   |   |   |   |   |   |
| Day of Week (01-07)                | 0             | 0    | 0    | 0   | 0  | U | U | U |   |   |   |   |   |   |                                    |               |      |   |   |   |   |   |   |               |  |   |   |   |   |   |   |   |
| 0x0089                             |               | 8    | I/O  | R/W | <b>RTC – Month</b><br><table border="1"> <thead> <tr> <th></th> <th>7</th> <th>6</th> <th>5</th> <th>4</th> <th>3</th> <th>2</th> <th>1</th> <th>0</th> </tr> </thead> <tbody> <tr> <td>Month (01-12)</td> <td>0</td> <td>0</td> <td>0</td> <td>T</td> <td>U</td> <td>U</td> <td>U</td> <td>U</td> </tr> </tbody> </table> <p>- T = Tens, U = Units</p>  |   | 7 | 6 | 5 | 4 | 3 | 2 | 1 | 0 | Month (01-12)                      | 0             | 0    | 0 | T | U | U | U | U |               |  |   |   |   |   |   |   |   |
|                                    | 7             | 6    | 5    | 4   | 3  | 2 | 1 | 0 |   |   |   |   |   |   |                                    |               |      |   |   |   |   |   |   |               |  |   |   |   |   |   |   |   |
| Month (01-12)                      | 0             | 0    | 0    | T   | U  | U | U | U |   |   |   |   |   |   |                                    |               |      |   |   |   |   |   |   |               |  |   |   |   |   |   |   |   |
| 0x008A                             |               | 8    | I/O  | R/W | <b>RTC – Year</b><br><table border="1"> <thead> <tr> <th></th> <th>7</th> <th>6</th> <th>5</th> <th>4</th> <th>3</th> <th>2</th> <th>1</th> <th>0</th> </tr> </thead> <tbody> <tr> <td>Years (99-00)</td> <td>T</td> <td>T</td> <td>T</td> <td>T</td> <td>U</td> <td>U</td> <td>U</td> <td>U</td> </tr> </tbody> </table> <p>- T = Tens, U = Units</p>   |   | 7 | 6 | 5 | 4 | 3 | 2 | 1 | 0 | Years (99-00)                      | T             | T    | T | T | U | U | U | U |               |  |   |   |   |   |   |   |   |
|                                    | 7             | 6    | 5    | 4   | 3  | 2 | 1 | 0 |   |   |   |   |   |   |                                    |               |      |   |   |   |   |   |   |               |  |   |   |   |   |   |   |   |
| Years (99-00)                      | T             | T    | T    | T   | U  | U | U | U |   |   |   |   |   |   |                                    |               |      |   |   |   |   |   |   |               |  |   |   |   |   |   |   |   |
| 0x008B                             |               | 8    | I/O  | R/W | <b>RTC – Rates</b><br><table border="1"> <thead> <tr> <th></th> <th>7</th> <th>6</th> <th>5</th> <th>4</th> <th>3</th> <th>2</th> <th>1</th> <th>0</th> </tr> </thead> <tbody> <tr> <td></td> <td></td> <td></td> <td></td> <td></td> <td></td> <td></td> <td></td> <td></td> </tr> </tbody> </table>  |   | 7 | 6 | 5 | 4 | 3 | 2 | 1 | 0 |                                    |               |      |   |   |   |   |   |   |               |  |   |   |   |   |   |   |   |
|                                    | 7             | 6    | 5    | 4   | 3  | 2 | 1 | 0 |   |   |   |   |   |   |                                    |               |      |   |   |   |   |   |   |               |  |   |   |   |   |   |   |   |
|                                    |               |      |      |     |  |   |   |   |   |   |   |   |   |   |                                    |               |      |   |   |   |   |   |   |               |  |   |   |   |   |   |   |   |

# A2560 FOENIX K - User Manual

|                 |               |          |            |            |   |       |               |      |   |   |              |   |   |   |         |   |     |     |     |      |       |       |      |                 |   |   |   |   |   |   |   |   |
|-----------------|---------------|----------|------------|------------|---|-------|---------------|------|---|---|--------------|---|---|---|---------|---|-----|-----|-----|------|-------|-------|------|-----------------|---|---|---|---|---|---|---|---|
|                 |               |          |            |            | <table border="1"> <tr> <td></td> <td>7</td> <td>6</td> <td>5</td> <td>4</td> <td>3</td> <td>2</td> <td>1</td> <td>0</td> </tr> <tr> <td>Rates</td> <td>0</td> <td>WD2</td> <td>WD1</td> <td>WD0</td> <td>RES3</td> <td>RES2</td> <td>RES1</td> <td>RES0</td> </tr> </table>  |       | 7             | 6    | 5 | 4 | 3            | 2 | 1 | 0 | Rates   | 0 | WD2 | WD1 | WD0 | RES3 | RES2  | RES1  | RES0 |                 |   |   |   |   |   |   |   |   |
|                 | 7             | 6        | 5          | 4          | 3   | 2     | 1             | 0    |   |   |              |   |   |   |         |   |     |     |     |      |       |       |      |                 |   |   |   |   |   |   |   |   |
| Rates           | 0             | WD2      | WD1        | WD0        | RES3  | RES2  | RES1          | RES0 |   |   |              |   |   |   |         |   |     |     |     |      |       |       |      |                 |   |   |   |   |   |   |   |   |
| <b>0x008C</b>   |               | <b>8</b> | <b>I/O</b> | <b>R/W</b> | <b>RTC - Enables</b><br><table border="1"> <tr> <td></td> <td>7</td> <td>6</td> <td>5</td> <td>4</td> <td>3</td> <td>2</td> <td>1</td> <td>0</td> </tr> <tr> <td>Enables</td> <td>0</td> <td>0</td> <td>0</td> <td>0</td> <td>AIE</td> <td>PIE</td> <td>PWRIE</td> <td>ABE</td> </tr> </table>  |       | 7             | 6    | 5 | 4 | 3            | 2 | 1 | 0 | Enables | 0 | 0   | 0   | 0   | AIE  | PIE   | PWRIE | ABE  |                 |   |   |   |   |   |   |   |   |
|                 | 7             | 6        | 5          | 4          | 3   | 2     | 1             | 0    |   |   |              |   |   |   |         |   |     |     |     |      |       |       |      |                 |   |   |   |   |   |   |   |   |
| Enables         | 0             | 0        | 0          | 0          | AIE   | PIE   | PWRIE         | ABE  |   |   |              |   |   |   |         |   |     |     |     |      |       |       |      |                 |   |   |   |   |   |   |   |   |
| <b>0x008D</b>   |               | <b>8</b> | <b>I/O</b> | <b>R/W</b> | <b>RTC - Flags</b><br><table border="1"> <tr> <td></td> <td>7</td> <td>6</td> <td>5</td> <td>4</td> <td>3</td> <td>2</td> <td>1</td> <td>0</td> </tr> <tr> <td>Flags</td> <td>0</td> <td>0</td> <td>0</td> <td>0</td> <td>AF</td> <td>PF</td> <td>PWRF</td> <td>BVF</td> </tr> </table>   |       | 7             | 6    | 5 | 4 | 3            | 2 | 1 | 0 | Flags   | 0 | 0   | 0   | 0   | AF   | PF    | PWRF  | BVF  |                 |   |   |   |   |   |   |   |   |
|                 | 7             | 6        | 5          | 4          | 3   | 2     | 1             | 0    |   |   |              |   |   |   |         |   |     |     |     |      |       |       |      |                 |   |   |   |   |   |   |   |   |
| Flags           | 0             | 0        | 0          | 0          | AF  | PF    | PWRF          | BVF  |   |   |              |   |   |   |         |   |     |     |     |      |       |       |      |                 |   |   |   |   |   |   |   |   |
| <b>0x008E</b>   |               | <b>8</b> | <b>I/O</b> | <b>R/W</b> | <b>RTC - Control</b><br><table border="1"> <tr> <td></td> <td>7</td> <td>6</td> <td>5</td> <td>4</td> <td>3</td> <td>2</td> <td>1</td> <td>0</td> </tr> <tr> <td>Control</td> <td>0</td> <td>0</td> <td>0</td> <td>0</td> <td>UTI</td> <td>STOPn</td> <td>24/12</td> <td>DSE</td> </tr> </table>  |       | 7             | 6    | 5 | 4 | 3            | 2 | 1 | 0 | Control | 0 | 0   | 0   | 0   | UTI  | STOPn | 24/12 | DSE  |                 |   |   |   |   |   |   |   |   |
|                 | 7             | 6        | 5          | 4          | 3   | 2     | 1             | 0    |   |   |              |   |   |   |         |   |     |     |     |      |       |       |      |                 |   |   |   |   |   |   |   |   |
| Control         | 0             | 0        | 0          | 0          | UTI   | STOPn | 24/12         | DSE  |   |   |              |   |   |   |         |   |     |     |     |      |       |       |      |                 |   |   |   |   |   |   |   |   |
| <b>0x008F</b>   |               | <b>8</b> | <b>I/O</b> | <b>R/W</b> | <b>RTC - Century</b><br><table border="1"> <tr> <td></td> <td colspan="4">10 Year Digit</td> <td colspan="4">1 Year Digit</td> </tr> <tr> <td></td> <td>7</td> <td>6</td> <td>5</td> <td>4</td> <td>3</td> <td>2</td> <td>1</td> <td>0</td> </tr> <tr> <td>Century (99-00)</td> <td>T</td> <td>T</td> <td>T</td> <td>T</td> <td>U</td> <td>U</td> <td>U</td> <td>U</td> </tr> </table> <p>T = Tens, U = Units</p> |       | 10 Year Digit |      |   |   | 1 Year Digit |   |   |   |         | 7 | 6   | 5   | 4   | 3    | 2     | 1     | 0    | Century (99-00) | T | T | T | T | U | U | U | U |
|                 | 10 Year Digit |          |            |            | 1 Year Digit  |       |               |      |   |   |              |   |   |   |         |   |     |     |     |      |       |       |      |                 |   |   |   |   |   |   |   |   |
|                 | 7             | 6        | 5          | 4          | 3   | 2     | 1             | 0    |   |   |              |   |   |   |         |   |     |     |     |      |       |       |      |                 |   |   |   |   |   |   |   |   |
| Century (99-00) | T             | T        | T          | T          | U   | U     | U             | U    |   |   |              |   |   |   |         |   |     |     |     |      |       |       |      |                 |   |   |   |   |   |   |   |   |

PRELIMINARY

9.1.4. Interrupt Controller Registers

| Addy Start Offset     | Addy End | Size | Type | R/W | Description   |                  |    |     |     |   |                  |    |    |    |    |    |    |   |   |   |   |   |                   |   |   |   |   |              |   |   |   |   |   |   |   |   |   |   |   |                  |   |   |   |   |                 |   |   |   |   |   |   |   |   |   |   |   |                  |   |   |   |   |           |   |   |   |   |   |   |   |   |   |   |   |                               |   |   |   |   |                   |   |   |   |   |   |   |   |   |   |   |   |                               |   |   |   |   |                    |   |   |   |   |   |   |   |   |   |   |   |                             |   |   |   |   |      |   |   |   |   |   |   |   |   |   |   |   |                             |   |   |   |   |          |   |   |   |   |   |   |   |   |   |   |   |          |   |   |   |   |                |   |   |   |   |   |   |   |   |   |   |   |                |   |   |   |   |                     |   |   |   |   |   |   |   |   |   |   |   |                   |   |   |   |   |                     |   |   |   |   |   |   |   |   |   |   |   |                  |   |   |   |   |                     |   |   |   |   |   |   |   |   |   |   |   |                  |   |   |   |   |                     |   |   |   |   |   |   |   |   |   |   |   |                               |   |   |   |   |                     |   |   |   |   |   |   |   |   |   |   |   |                               |   |   |   |   |               |   |   |   |   |   |   |   |   |   |   |   |                             |   |   |   |   |             |   |   |   |   |   |   |   |   |   |   |   |                             |   |   |   |   |               |   |   |   |   |   |   |   |   |   |   |   |          |   |   |   |   |   |   |   |   |   |   |   |   |   |   |   |   |                |   |   |   |   |   |   |   |   |   |   |   |   |   |   |   |   |
|-----------------------|----------|------|------|-----|---|------------------|----|-----|-----|---|------------------|----|----|----|----|----|----|---|---|---|---|---|-------------------|---|---|---|---|--------------|---|---|---|---|---|---|---|---|---|---|---|------------------|---|---|---|---|-----------------|---|---|---|---|---|---|---|---|---|---|---|------------------|---|---|---|---|-----------|---|---|---|---|---|---|---|---|---|---|---|-------------------------------|---|---|---|---|-------------------|---|---|---|---|---|---|---|---|---|---|---|-------------------------------|---|---|---|---|--------------------|---|---|---|---|---|---|---|---|---|---|---|-----------------------------|---|---|---|---|------|---|---|---|---|---|---|---|---|---|---|---|-----------------------------|---|---|---|---|----------|---|---|---|---|---|---|---|---|---|---|---|----------|---|---|---|---|----------------|---|---|---|---|---|---|---|---|---|---|---|----------------|---|---|---|---|---------------------|---|---|---|---|---|---|---|---|---|---|---|-------------------|---|---|---|---|---------------------|---|---|---|---|---|---|---|---|---|---|---|------------------|---|---|---|---|---------------------|---|---|---|---|---|---|---|---|---|---|---|------------------|---|---|---|---|---------------------|---|---|---|---|---|---|---|---|---|---|---|-------------------------------|---|---|---|---|---------------------|---|---|---|---|---|---|---|---|---|---|---|-------------------------------|---|---|---|---|---------------|---|---|---|---|---|---|---|---|---|---|---|-----------------------------|---|---|---|---|-------------|---|---|---|---|---|---|---|---|---|---|---|-----------------------------|---|---|---|---|---------------|---|---|---|---|---|---|---|---|---|---|---|----------|---|---|---|---|---|---|---|---|---|---|---|---|---|---|---|---|----------------|---|---|---|---|---|---|---|---|---|---|---|---|---|---|---|---|
| 0x0100                |          | 16   | I/O  | R/W | <b>Interrupt Pending Register Group 0 (VICKY)</b>   |                  |    |     |     |   |                  |    |    |    |    |    |    |   |   |   |   |   |                   |   |   |   |   |              |   |   |   |   |   |   |   |   |   |   |   |                  |   |   |   |   |                 |   |   |   |   |   |   |   |   |   |   |   |                  |   |   |   |   |           |   |   |   |   |   |   |   |   |   |   |   |                               |   |   |   |   |                   |   |   |   |   |   |   |   |   |   |   |   |                               |   |   |   |   |                    |   |   |   |   |   |   |   |   |   |   |   |                             |   |   |   |   |      |   |   |   |   |   |   |   |   |   |   |   |                             |   |   |   |   |          |   |   |   |   |   |   |   |   |   |   |   |          |   |   |   |   |                |   |   |   |   |   |   |   |   |   |   |   |                |   |   |   |   |                     |   |   |   |   |   |   |   |   |   |   |   |                   |   |   |   |   |                     |   |   |   |   |   |   |   |   |   |   |   |                  |   |   |   |   |                     |   |   |   |   |   |   |   |   |   |   |   |                  |   |   |   |   |                     |   |   |   |   |   |   |   |   |   |   |   |                               |   |   |   |   |                     |   |   |   |   |   |   |   |   |   |   |   |                               |   |   |   |   |               |   |   |   |   |   |   |   |   |   |   |   |                             |   |   |   |   |             |   |   |   |   |   |   |   |   |   |   |   |                             |   |   |   |   |               |   |   |   |   |   |   |   |   |   |   |   |          |   |   |   |   |   |   |   |   |   |   |   |   |   |   |   |   |                |   |   |   |   |   |   |   |   |   |   |   |   |   |   |   |   |
|                       |          |      |      |     | <table border="1"> <thead> <tr> <th>Interrupt Source</th> <th>15</th><th>14</th><th>13</th><th>12</th><th>11</th><th>10</th><th>9</th><th>8</th><th>7</th><th>6</th><th>5</th><th>4</th><th>3</th><th>2</th><th>1</th><th>0</th> </tr> </thead> <tbody> <tr> <td>VKY III Channel A</td> <td></td><td></td><td></td><td></td><td></td><td></td><td></td><td></td><td></td><td></td><td></td><td></td><td></td><td></td><td></td><td></td> </tr> <tr> <td>VICKY INT0 (SOF)</td> <td>0</td><td>0</td><td>0</td><td>0</td><td>0</td><td>0</td><td>0</td><td>0</td><td>0</td><td>0</td><td>0</td><td>0</td><td>0</td><td>0</td><td>0</td><td>1</td> </tr> <tr> <td>VICKY INT1 (SOL)</td> <td>0</td><td>0</td><td>0</td><td>0</td><td>0</td><td>0</td><td>0</td><td>0</td><td>0</td><td>0</td><td>0</td><td>0</td><td>0</td><td>0</td><td>1</td><td>0</td> </tr> <tr> <td>VICKY INT2 (Sprite Collision)</td> <td>0</td><td>0</td><td>0</td><td>0</td><td>0</td><td>0</td><td>0</td><td>0</td><td>0</td><td>0</td><td>0</td><td>0</td><td>0</td><td>1</td><td>0</td><td>0</td> </tr> <tr> <td>VICKY INT3 (Bitmap Collision)</td> <td>0</td><td>0</td><td>0</td><td>0</td><td>0</td><td>0</td><td>0</td><td>0</td><td>0</td><td>0</td><td>0</td><td>0</td><td>1</td><td>0</td><td>0</td><td>0</td> </tr> <tr> <td>VICKY INT4 (VDMA Interrupt)</td> <td>0</td><td>0</td><td>0</td><td>0</td><td>0</td><td>0</td><td>0</td><td>0</td><td>0</td><td>0</td><td>0</td><td>1</td><td>0</td><td>0</td><td>0</td><td>0</td> </tr> <tr> <td>VICKY INT5 (Tile Collision)</td> <td>0</td><td>0</td><td>0</td><td>0</td><td>0</td><td>0</td><td>0</td><td>0</td><td>0</td><td>0</td><td>1</td><td>0</td><td>0</td><td>0</td><td>0</td><td>0</td> </tr> <tr> <td>Reserved</td> <td>0</td><td>0</td><td>0</td><td>0</td><td>0</td><td>0</td><td>0</td><td>0</td><td>0</td><td>0</td><td>1</td><td>0</td><td>0</td><td>0</td><td>0</td><td>0</td> </tr> <tr> <td>VICKY Hot-Plug</td> <td>0</td><td>0</td><td>0</td><td>0</td><td>0</td><td>0</td><td>0</td><td>0</td><td>0</td><td>1</td><td>0</td><td>0</td><td>0</td><td>0</td><td>0</td><td>0</td> </tr> <tr> <td>VKY III Channel B</td> <td></td><td></td><td></td><td></td><td></td><td></td><td></td><td></td><td></td><td></td><td></td><td></td><td></td><td></td><td></td><td></td> </tr> <tr> <td>VICKY INT0 (SOF)</td> <td>0</td><td>0</td><td>0</td><td>0</td><td>0</td><td>0</td><td>0</td><td>1</td><td>0</td><td>0</td><td>0</td><td>0</td><td>0</td><td>0</td><td>0</td><td>0</td> </tr> <tr> <td>VICKY INT1 (SOL)</td> <td>0</td><td>0</td><td>0</td><td>0</td><td>0</td><td>0</td><td>1</td><td>0</td><td>0</td><td>0</td><td>0</td><td>0</td><td>0</td><td>0</td><td>0</td><td>0</td> </tr> <tr> <td>VICKY INT2 (Sprite Collision)</td> <td>0</td><td>0</td><td>0</td><td>0</td><td>0</td><td>1</td><td>0</td><td>0</td><td>0</td><td>0</td><td>0</td><td>0</td><td>0</td><td>0</td><td>0</td><td>0</td> </tr> <tr> <td>VICKY INT3 (Bitmap Collision)</td> <td>0</td><td>0</td><td>0</td><td>0</td><td>1</td><td>0</td><td>0</td><td>0</td><td>0</td><td>0</td><td>0</td><td>0</td><td>0</td><td>0</td><td>0</td><td>0</td> </tr> <tr> <td>VICKY INT4 (VDMA Interrupt)</td> <td>0</td><td>0</td><td>0</td><td>1</td><td>0</td><td>0</td><td>0</td><td>0</td><td>0</td><td>0</td><td>0</td><td>0</td><td>0</td><td>0</td><td>0</td><td>0</td> </tr> <tr> <td>VICKY INT5 (Tile Collision)</td> <td>0</td><td>0</td><td>1</td><td>0</td><td>0</td><td>0</td><td>0</td><td>0</td><td>0</td><td>0</td><td>0</td><td>0</td><td>0</td><td>0</td><td>0</td><td>0</td> </tr> <tr> <td>Reserved</td> <td>0</td><td>1</td><td>0</td><td>0</td><td>0</td><td>0</td><td>0</td><td>0</td><td>0</td><td>0</td><td>0</td><td>0</td><td>0</td><td>0</td><td>0</td><td>0</td> </tr> <tr> <td>VICKY Hot-Plug</td> <td>1</td><td>0</td><td>0</td><td>0</td><td>0</td><td>0</td><td>0</td><td>0</td><td>0</td><td>0</td><td>0</td><td>0</td><td>0</td><td>0</td><td>0</td><td>0</td> </tr> </tbody> </table> | Interrupt Source | 15 | 14  | 13  | 12  | 11               | 10 | 9  | 8  | 7  | 6  | 5  | 4 | 3 | 2 | 1 | 0 | VKY III Channel A |   |   |   |   |              |   |   |   |   |   |   |   |   |   |   |   | VICKY INT0 (SOF) | 0 | 0 | 0 | 0 | 0               | 0 | 0 | 0 | 0 | 0 | 0 | 0 | 0 | 0 | 0 | 1 | VICKY INT1 (SOL) | 0 | 0 | 0 | 0 | 0         | 0 | 0 | 0 | 0 | 0 | 0 | 0 | 0 | 0 | 1 | 0 | VICKY INT2 (Sprite Collision) | 0 | 0 | 0 | 0 | 0                 | 0 | 0 | 0 | 0 | 0 | 0 | 0 | 0 | 1 | 0 | 0 | VICKY INT3 (Bitmap Collision) | 0 | 0 | 0 | 0 | 0                  | 0 | 0 | 0 | 0 | 0 | 0 | 0 | 1 | 0 | 0 | 0 | VICKY INT4 (VDMA Interrupt) | 0 | 0 | 0 | 0 | 0    | 0 | 0 | 0 | 0 | 0 | 0 | 1 | 0 | 0 | 0 | 0 | VICKY INT5 (Tile Collision) | 0 | 0 | 0 | 0 | 0        | 0 | 0 | 0 | 0 | 0 | 1 | 0 | 0 | 0 | 0 | 0 | Reserved | 0 | 0 | 0 | 0 | 0              | 0 | 0 | 0 | 0 | 0 | 1 | 0 | 0 | 0 | 0 | 0 | VICKY Hot-Plug | 0 | 0 | 0 | 0 | 0                   | 0 | 0 | 0 | 0 | 1 | 0 | 0 | 0 | 0 | 0 | 0 | VKY III Channel B |   |   |   |   |                     |   |   |   |   |   |   |   |   |   |   |   | VICKY INT0 (SOF) | 0 | 0 | 0 | 0 | 0                   | 0 | 0 | 1 | 0 | 0 | 0 | 0 | 0 | 0 | 0 | 0 | VICKY INT1 (SOL) | 0 | 0 | 0 | 0 | 0                   | 0 | 1 | 0 | 0 | 0 | 0 | 0 | 0 | 0 | 0 | 0 | VICKY INT2 (Sprite Collision) | 0 | 0 | 0 | 0 | 0                   | 1 | 0 | 0 | 0 | 0 | 0 | 0 | 0 | 0 | 0 | 0 | VICKY INT3 (Bitmap Collision) | 0 | 0 | 0 | 0 | 1             | 0 | 0 | 0 | 0 | 0 | 0 | 0 | 0 | 0 | 0 | 0 | VICKY INT4 (VDMA Interrupt) | 0 | 0 | 0 | 1 | 0           | 0 | 0 | 0 | 0 | 0 | 0 | 0 | 0 | 0 | 0 | 0 | VICKY INT5 (Tile Collision) | 0 | 0 | 1 | 0 | 0             | 0 | 0 | 0 | 0 | 0 | 0 | 0 | 0 | 0 | 0 | 0 | Reserved | 0 | 1 | 0 | 0 | 0 | 0 | 0 | 0 | 0 | 0 | 0 | 0 | 0 | 0 | 0 | 0 | VICKY Hot-Plug | 1 | 0 | 0 | 0 | 0 | 0 | 0 | 0 | 0 | 0 | 0 | 0 | 0 | 0 | 0 | 0 |
|                       |          |      |      |     | Interrupt Source  | 15               | 14 | 13  | 12  | 11  | 10               | 9  | 8  | 7  | 6  | 5  | 4  | 3 | 2 | 1 | 0 |   |                   |   |   |   |   |              |   |   |   |   |   |   |   |   |   |   |   |                  |   |   |   |   |                 |   |   |   |   |   |   |   |   |   |   |   |                  |   |   |   |   |           |   |   |   |   |   |   |   |   |   |   |   |                               |   |   |   |   |                   |   |   |   |   |   |   |   |   |   |   |   |                               |   |   |   |   |                    |   |   |   |   |   |   |   |   |   |   |   |                             |   |   |   |   |      |   |   |   |   |   |   |   |   |   |   |   |                             |   |   |   |   |          |   |   |   |   |   |   |   |   |   |   |   |          |   |   |   |   |                |   |   |   |   |   |   |   |   |   |   |   |                |   |   |   |   |                     |   |   |   |   |   |   |   |   |   |   |   |                   |   |   |   |   |                     |   |   |   |   |   |   |   |   |   |   |   |                  |   |   |   |   |                     |   |   |   |   |   |   |   |   |   |   |   |                  |   |   |   |   |                     |   |   |   |   |   |   |   |   |   |   |   |                               |   |   |   |   |                     |   |   |   |   |   |   |   |   |   |   |   |                               |   |   |   |   |               |   |   |   |   |   |   |   |   |   |   |   |                             |   |   |   |   |             |   |   |   |   |   |   |   |   |   |   |   |                             |   |   |   |   |               |   |   |   |   |   |   |   |   |   |   |   |          |   |   |   |   |   |   |   |   |   |   |   |   |   |   |   |   |                |   |   |   |   |   |   |   |   |   |   |   |   |   |   |   |   |
|                       |          |      |      |     | VKY III Channel A   |                  |    |     |     |   |                  |    |    |    |    |    |    |   |   |   |   |   |                   |   |   |   |   |              |   |   |   |   |   |   |   |   |   |   |   |                  |   |   |   |   |                 |   |   |   |   |   |   |   |   |   |   |   |                  |   |   |   |   |           |   |   |   |   |   |   |   |   |   |   |   |                               |   |   |   |   |                   |   |   |   |   |   |   |   |   |   |   |   |                               |   |   |   |   |                    |   |   |   |   |   |   |   |   |   |   |   |                             |   |   |   |   |      |   |   |   |   |   |   |   |   |   |   |   |                             |   |   |   |   |          |   |   |   |   |   |   |   |   |   |   |   |          |   |   |   |   |                |   |   |   |   |   |   |   |   |   |   |   |                |   |   |   |   |                     |   |   |   |   |   |   |   |   |   |   |   |                   |   |   |   |   |                     |   |   |   |   |   |   |   |   |   |   |   |                  |   |   |   |   |                     |   |   |   |   |   |   |   |   |   |   |   |                  |   |   |   |   |                     |   |   |   |   |   |   |   |   |   |   |   |                               |   |   |   |   |                     |   |   |   |   |   |   |   |   |   |   |   |                               |   |   |   |   |               |   |   |   |   |   |   |   |   |   |   |   |                             |   |   |   |   |             |   |   |   |   |   |   |   |   |   |   |   |                             |   |   |   |   |               |   |   |   |   |   |   |   |   |   |   |   |          |   |   |   |   |   |   |   |   |   |   |   |   |   |   |   |   |                |   |   |   |   |   |   |   |   |   |   |   |   |   |   |   |   |
|                       |          |      |      |     | VICKY INT0 (SOF)  | 0                | 0  | 0   | 0   | 0   | 0                | 0  | 0  | 0  | 0  | 0  | 0  | 0 | 0 | 0 | 1 |   |                   |   |   |   |   |              |   |   |   |   |   |   |   |   |   |   |   |                  |   |   |   |   |                 |   |   |   |   |   |   |   |   |   |   |   |                  |   |   |   |   |           |   |   |   |   |   |   |   |   |   |   |   |                               |   |   |   |   |                   |   |   |   |   |   |   |   |   |   |   |   |                               |   |   |   |   |                    |   |   |   |   |   |   |   |   |   |   |   |                             |   |   |   |   |      |   |   |   |   |   |   |   |   |   |   |   |                             |   |   |   |   |          |   |   |   |   |   |   |   |   |   |   |   |          |   |   |   |   |                |   |   |   |   |   |   |   |   |   |   |   |                |   |   |   |   |                     |   |   |   |   |   |   |   |   |   |   |   |                   |   |   |   |   |                     |   |   |   |   |   |   |   |   |   |   |   |                  |   |   |   |   |                     |   |   |   |   |   |   |   |   |   |   |   |                  |   |   |   |   |                     |   |   |   |   |   |   |   |   |   |   |   |                               |   |   |   |   |                     |   |   |   |   |   |   |   |   |   |   |   |                               |   |   |   |   |               |   |   |   |   |   |   |   |   |   |   |   |                             |   |   |   |   |             |   |   |   |   |   |   |   |   |   |   |   |                             |   |   |   |   |               |   |   |   |   |   |   |   |   |   |   |   |          |   |   |   |   |   |   |   |   |   |   |   |   |   |   |   |   |                |   |   |   |   |   |   |   |   |   |   |   |   |   |   |   |   |
|                       |          |      |      |     | VICKY INT1 (SOL)  | 0                | 0  | 0   | 0   | 0   | 0                | 0  | 0  | 0  | 0  | 0  | 0  | 0 | 0 | 1 | 0 |   |                   |   |   |   |   |              |   |   |   |   |   |   |   |   |   |   |   |                  |   |   |   |   |                 |   |   |   |   |   |   |   |   |   |   |   |                  |   |   |   |   |           |   |   |   |   |   |   |   |   |   |   |   |                               |   |   |   |   |                   |   |   |   |   |   |   |   |   |   |   |   |                               |   |   |   |   |                    |   |   |   |   |   |   |   |   |   |   |   |                             |   |   |   |   |      |   |   |   |   |   |   |   |   |   |   |   |                             |   |   |   |   |          |   |   |   |   |   |   |   |   |   |   |   |          |   |   |   |   |                |   |   |   |   |   |   |   |   |   |   |   |                |   |   |   |   |                     |   |   |   |   |   |   |   |   |   |   |   |                   |   |   |   |   |                     |   |   |   |   |   |   |   |   |   |   |   |                  |   |   |   |   |                     |   |   |   |   |   |   |   |   |   |   |   |                  |   |   |   |   |                     |   |   |   |   |   |   |   |   |   |   |   |                               |   |   |   |   |                     |   |   |   |   |   |   |   |   |   |   |   |                               |   |   |   |   |               |   |   |   |   |   |   |   |   |   |   |   |                             |   |   |   |   |             |   |   |   |   |   |   |   |   |   |   |   |                             |   |   |   |   |               |   |   |   |   |   |   |   |   |   |   |   |          |   |   |   |   |   |   |   |   |   |   |   |   |   |   |   |   |                |   |   |   |   |   |   |   |   |   |   |   |   |   |   |   |   |
|                       |          |      |      |     | VICKY INT2 (Sprite Collision)   | 0                | 0  | 0   | 0   | 0   | 0                | 0  | 0  | 0  | 0  | 0  | 0  | 0 | 1 | 0 | 0 |   |                   |   |   |   |   |              |   |   |   |   |   |   |   |   |   |   |   |                  |   |   |   |   |                 |   |   |   |   |   |   |   |   |   |   |   |                  |   |   |   |   |           |   |   |   |   |   |   |   |   |   |   |   |                               |   |   |   |   |                   |   |   |   |   |   |   |   |   |   |   |   |                               |   |   |   |   |                    |   |   |   |   |   |   |   |   |   |   |   |                             |   |   |   |   |      |   |   |   |   |   |   |   |   |   |   |   |                             |   |   |   |   |          |   |   |   |   |   |   |   |   |   |   |   |          |   |   |   |   |                |   |   |   |   |   |   |   |   |   |   |   |                |   |   |   |   |                     |   |   |   |   |   |   |   |   |   |   |   |                   |   |   |   |   |                     |   |   |   |   |   |   |   |   |   |   |   |                  |   |   |   |   |                     |   |   |   |   |   |   |   |   |   |   |   |                  |   |   |   |   |                     |   |   |   |   |   |   |   |   |   |   |   |                               |   |   |   |   |                     |   |   |   |   |   |   |   |   |   |   |   |                               |   |   |   |   |               |   |   |   |   |   |   |   |   |   |   |   |                             |   |   |   |   |             |   |   |   |   |   |   |   |   |   |   |   |                             |   |   |   |   |               |   |   |   |   |   |   |   |   |   |   |   |          |   |   |   |   |   |   |   |   |   |   |   |   |   |   |   |   |                |   |   |   |   |   |   |   |   |   |   |   |   |   |   |   |   |
|                       |          |      |      |     | VICKY INT3 (Bitmap Collision)   | 0                | 0  | 0   | 0   | 0   | 0                | 0  | 0  | 0  | 0  | 0  | 0  | 1 | 0 | 0 | 0 |   |                   |   |   |   |   |              |   |   |   |   |   |   |   |   |   |   |   |                  |   |   |   |   |                 |   |   |   |   |   |   |   |   |   |   |   |                  |   |   |   |   |           |   |   |   |   |   |   |   |   |   |   |   |                               |   |   |   |   |                   |   |   |   |   |   |   |   |   |   |   |   |                               |   |   |   |   |                    |   |   |   |   |   |   |   |   |   |   |   |                             |   |   |   |   |      |   |   |   |   |   |   |   |   |   |   |   |                             |   |   |   |   |          |   |   |   |   |   |   |   |   |   |   |   |          |   |   |   |   |                |   |   |   |   |   |   |   |   |   |   |   |                |   |   |   |   |                     |   |   |   |   |   |   |   |   |   |   |   |                   |   |   |   |   |                     |   |   |   |   |   |   |   |   |   |   |   |                  |   |   |   |   |                     |   |   |   |   |   |   |   |   |   |   |   |                  |   |   |   |   |                     |   |   |   |   |   |   |   |   |   |   |   |                               |   |   |   |   |                     |   |   |   |   |   |   |   |   |   |   |   |                               |   |   |   |   |               |   |   |   |   |   |   |   |   |   |   |   |                             |   |   |   |   |             |   |   |   |   |   |   |   |   |   |   |   |                             |   |   |   |   |               |   |   |   |   |   |   |   |   |   |   |   |          |   |   |   |   |   |   |   |   |   |   |   |   |   |   |   |   |                |   |   |   |   |   |   |   |   |   |   |   |   |   |   |   |   |
|                       |          |      |      |     | VICKY INT4 (VDMA Interrupt)   | 0                | 0  | 0   | 0   | 0   | 0                | 0  | 0  | 0  | 0  | 0  | 1  | 0 | 0 | 0 | 0 |   |                   |   |   |   |   |              |   |   |   |   |   |   |   |   |   |   |   |                  |   |   |   |   |                 |   |   |   |   |   |   |   |   |   |   |   |                  |   |   |   |   |           |   |   |   |   |   |   |   |   |   |   |   |                               |   |   |   |   |                   |   |   |   |   |   |   |   |   |   |   |   |                               |   |   |   |   |                    |   |   |   |   |   |   |   |   |   |   |   |                             |   |   |   |   |      |   |   |   |   |   |   |   |   |   |   |   |                             |   |   |   |   |          |   |   |   |   |   |   |   |   |   |   |   |          |   |   |   |   |                |   |   |   |   |   |   |   |   |   |   |   |                |   |   |   |   |                     |   |   |   |   |   |   |   |   |   |   |   |                   |   |   |   |   |                     |   |   |   |   |   |   |   |   |   |   |   |                  |   |   |   |   |                     |   |   |   |   |   |   |   |   |   |   |   |                  |   |   |   |   |                     |   |   |   |   |   |   |   |   |   |   |   |                               |   |   |   |   |                     |   |   |   |   |   |   |   |   |   |   |   |                               |   |   |   |   |               |   |   |   |   |   |   |   |   |   |   |   |                             |   |   |   |   |             |   |   |   |   |   |   |   |   |   |   |   |                             |   |   |   |   |               |   |   |   |   |   |   |   |   |   |   |   |          |   |   |   |   |   |   |   |   |   |   |   |   |   |   |   |   |                |   |   |   |   |   |   |   |   |   |   |   |   |   |   |   |   |
|                       |          |      |      |     | VICKY INT5 (Tile Collision)   | 0                | 0  | 0   | 0   | 0   | 0                | 0  | 0  | 0  | 0  | 1  | 0  | 0 | 0 | 0 | 0 |   |                   |   |   |   |   |              |   |   |   |   |   |   |   |   |   |   |   |                  |   |   |   |   |                 |   |   |   |   |   |   |   |   |   |   |   |                  |   |   |   |   |           |   |   |   |   |   |   |   |   |   |   |   |                               |   |   |   |   |                   |   |   |   |   |   |   |   |   |   |   |   |                               |   |   |   |   |                    |   |   |   |   |   |   |   |   |   |   |   |                             |   |   |   |   |      |   |   |   |   |   |   |   |   |   |   |   |                             |   |   |   |   |          |   |   |   |   |   |   |   |   |   |   |   |          |   |   |   |   |                |   |   |   |   |   |   |   |   |   |   |   |                |   |   |   |   |                     |   |   |   |   |   |   |   |   |   |   |   |                   |   |   |   |   |                     |   |   |   |   |   |   |   |   |   |   |   |                  |   |   |   |   |                     |   |   |   |   |   |   |   |   |   |   |   |                  |   |   |   |   |                     |   |   |   |   |   |   |   |   |   |   |   |                               |   |   |   |   |                     |   |   |   |   |   |   |   |   |   |   |   |                               |   |   |   |   |               |   |   |   |   |   |   |   |   |   |   |   |                             |   |   |   |   |             |   |   |   |   |   |   |   |   |   |   |   |                             |   |   |   |   |               |   |   |   |   |   |   |   |   |   |   |   |          |   |   |   |   |   |   |   |   |   |   |   |   |   |   |   |   |                |   |   |   |   |   |   |   |   |   |   |   |   |   |   |   |   |
|                       |          |      |      |     | Reserved  | 0                | 0  | 0   | 0   | 0   | 0                | 0  | 0  | 0  | 0  | 1  | 0  | 0 | 0 | 0 | 0 |   |                   |   |   |   |   |              |   |   |   |   |   |   |   |   |   |   |   |                  |   |   |   |   |                 |   |   |   |   |   |   |   |   |   |   |   |                  |   |   |   |   |           |   |   |   |   |   |   |   |   |   |   |   |                               |   |   |   |   |                   |   |   |   |   |   |   |   |   |   |   |   |                               |   |   |   |   |                    |   |   |   |   |   |   |   |   |   |   |   |                             |   |   |   |   |      |   |   |   |   |   |   |   |   |   |   |   |                             |   |   |   |   |          |   |   |   |   |   |   |   |   |   |   |   |          |   |   |   |   |                |   |   |   |   |   |   |   |   |   |   |   |                |   |   |   |   |                     |   |   |   |   |   |   |   |   |   |   |   |                   |   |   |   |   |                     |   |   |   |   |   |   |   |   |   |   |   |                  |   |   |   |   |                     |   |   |   |   |   |   |   |   |   |   |   |                  |   |   |   |   |                     |   |   |   |   |   |   |   |   |   |   |   |                               |   |   |   |   |                     |   |   |   |   |   |   |   |   |   |   |   |                               |   |   |   |   |               |   |   |   |   |   |   |   |   |   |   |   |                             |   |   |   |   |             |   |   |   |   |   |   |   |   |   |   |   |                             |   |   |   |   |               |   |   |   |   |   |   |   |   |   |   |   |          |   |   |   |   |   |   |   |   |   |   |   |   |   |   |   |   |                |   |   |   |   |   |   |   |   |   |   |   |   |   |   |   |   |
|                       |          |      |      |     | VICKY Hot-Plug  | 0                | 0  | 0   | 0   | 0   | 0                | 0  | 0  | 0  | 1  | 0  | 0  | 0 | 0 | 0 | 0 |   |                   |   |   |   |   |              |   |   |   |   |   |   |   |   |   |   |   |                  |   |   |   |   |                 |   |   |   |   |   |   |   |   |   |   |   |                  |   |   |   |   |           |   |   |   |   |   |   |   |   |   |   |   |                               |   |   |   |   |                   |   |   |   |   |   |   |   |   |   |   |   |                               |   |   |   |   |                    |   |   |   |   |   |   |   |   |   |   |   |                             |   |   |   |   |      |   |   |   |   |   |   |   |   |   |   |   |                             |   |   |   |   |          |   |   |   |   |   |   |   |   |   |   |   |          |   |   |   |   |                |   |   |   |   |   |   |   |   |   |   |   |                |   |   |   |   |                     |   |   |   |   |   |   |   |   |   |   |   |                   |   |   |   |   |                     |   |   |   |   |   |   |   |   |   |   |   |                  |   |   |   |   |                     |   |   |   |   |   |   |   |   |   |   |   |                  |   |   |   |   |                     |   |   |   |   |   |   |   |   |   |   |   |                               |   |   |   |   |                     |   |   |   |   |   |   |   |   |   |   |   |                               |   |   |   |   |               |   |   |   |   |   |   |   |   |   |   |   |                             |   |   |   |   |             |   |   |   |   |   |   |   |   |   |   |   |                             |   |   |   |   |               |   |   |   |   |   |   |   |   |   |   |   |          |   |   |   |   |   |   |   |   |   |   |   |   |   |   |   |   |                |   |   |   |   |   |   |   |   |   |   |   |   |   |   |   |   |
|                       |          |      |      |     | VKY III Channel B   |                  |    |     |     |   |                  |    |    |    |    |    |    |   |   |   |   |   |                   |   |   |   |   |              |   |   |   |   |   |   |   |   |   |   |   |                  |   |   |   |   |                 |   |   |   |   |   |   |   |   |   |   |   |                  |   |   |   |   |           |   |   |   |   |   |   |   |   |   |   |   |                               |   |   |   |   |                   |   |   |   |   |   |   |   |   |   |   |   |                               |   |   |   |   |                    |   |   |   |   |   |   |   |   |   |   |   |                             |   |   |   |   |      |   |   |   |   |   |   |   |   |   |   |   |                             |   |   |   |   |          |   |   |   |   |   |   |   |   |   |   |   |          |   |   |   |   |                |   |   |   |   |   |   |   |   |   |   |   |                |   |   |   |   |                     |   |   |   |   |   |   |   |   |   |   |   |                   |   |   |   |   |                     |   |   |   |   |   |   |   |   |   |   |   |                  |   |   |   |   |                     |   |   |   |   |   |   |   |   |   |   |   |                  |   |   |   |   |                     |   |   |   |   |   |   |   |   |   |   |   |                               |   |   |   |   |                     |   |   |   |   |   |   |   |   |   |   |   |                               |   |   |   |   |               |   |   |   |   |   |   |   |   |   |   |   |                             |   |   |   |   |             |   |   |   |   |   |   |   |   |   |   |   |                             |   |   |   |   |               |   |   |   |   |   |   |   |   |   |   |   |          |   |   |   |   |   |   |   |   |   |   |   |   |   |   |   |   |                |   |   |   |   |   |   |   |   |   |   |   |   |   |   |   |   |
|                       |          |      |      |     | VICKY INT0 (SOF)  | 0                | 0  | 0   | 0   | 0   | 0                | 0  | 1  | 0  | 0  | 0  | 0  | 0 | 0 | 0 | 0 |   |                   |   |   |   |   |              |   |   |   |   |   |   |   |   |   |   |   |                  |   |   |   |   |                 |   |   |   |   |   |   |   |   |   |   |   |                  |   |   |   |   |           |   |   |   |   |   |   |   |   |   |   |   |                               |   |   |   |   |                   |   |   |   |   |   |   |   |   |   |   |   |                               |   |   |   |   |                    |   |   |   |   |   |   |   |   |   |   |   |                             |   |   |   |   |      |   |   |   |   |   |   |   |   |   |   |   |                             |   |   |   |   |          |   |   |   |   |   |   |   |   |   |   |   |          |   |   |   |   |                |   |   |   |   |   |   |   |   |   |   |   |                |   |   |   |   |                     |   |   |   |   |   |   |   |   |   |   |   |                   |   |   |   |   |                     |   |   |   |   |   |   |   |   |   |   |   |                  |   |   |   |   |                     |   |   |   |   |   |   |   |   |   |   |   |                  |   |   |   |   |                     |   |   |   |   |   |   |   |   |   |   |   |                               |   |   |   |   |                     |   |   |   |   |   |   |   |   |   |   |   |                               |   |   |   |   |               |   |   |   |   |   |   |   |   |   |   |   |                             |   |   |   |   |             |   |   |   |   |   |   |   |   |   |   |   |                             |   |   |   |   |               |   |   |   |   |   |   |   |   |   |   |   |          |   |   |   |   |   |   |   |   |   |   |   |   |   |   |   |   |                |   |   |   |   |   |   |   |   |   |   |   |   |   |   |   |   |
|                       |          |      |      |     | VICKY INT1 (SOL)  | 0                | 0  | 0   | 0   | 0   | 0                | 1  | 0  | 0  | 0  | 0  | 0  | 0 | 0 | 0 | 0 |   |                   |   |   |   |   |              |   |   |   |   |   |   |   |   |   |   |   |                  |   |   |   |   |                 |   |   |   |   |   |   |   |   |   |   |   |                  |   |   |   |   |           |   |   |   |   |   |   |   |   |   |   |   |                               |   |   |   |   |                   |   |   |   |   |   |   |   |   |   |   |   |                               |   |   |   |   |                    |   |   |   |   |   |   |   |   |   |   |   |                             |   |   |   |   |      |   |   |   |   |   |   |   |   |   |   |   |                             |   |   |   |   |          |   |   |   |   |   |   |   |   |   |   |   |          |   |   |   |   |                |   |   |   |   |   |   |   |   |   |   |   |                |   |   |   |   |                     |   |   |   |   |   |   |   |   |   |   |   |                   |   |   |   |   |                     |   |   |   |   |   |   |   |   |   |   |   |                  |   |   |   |   |                     |   |   |   |   |   |   |   |   |   |   |   |                  |   |   |   |   |                     |   |   |   |   |   |   |   |   |   |   |   |                               |   |   |   |   |                     |   |   |   |   |   |   |   |   |   |   |   |                               |   |   |   |   |               |   |   |   |   |   |   |   |   |   |   |   |                             |   |   |   |   |             |   |   |   |   |   |   |   |   |   |   |   |                             |   |   |   |   |               |   |   |   |   |   |   |   |   |   |   |   |          |   |   |   |   |   |   |   |   |   |   |   |   |   |   |   |   |                |   |   |   |   |   |   |   |   |   |   |   |   |   |   |   |   |
|                       |          |      |      |     | VICKY INT2 (Sprite Collision)   | 0                | 0  | 0   | 0   | 0   | 1                | 0  | 0  | 0  | 0  | 0  | 0  | 0 | 0 | 0 | 0 |   |                   |   |   |   |   |              |   |   |   |   |   |   |   |   |   |   |   |                  |   |   |   |   |                 |   |   |   |   |   |   |   |   |   |   |   |                  |   |   |   |   |           |   |   |   |   |   |   |   |   |   |   |   |                               |   |   |   |   |                   |   |   |   |   |   |   |   |   |   |   |   |                               |   |   |   |   |                    |   |   |   |   |   |   |   |   |   |   |   |                             |   |   |   |   |      |   |   |   |   |   |   |   |   |   |   |   |                             |   |   |   |   |          |   |   |   |   |   |   |   |   |   |   |   |          |   |   |   |   |                |   |   |   |   |   |   |   |   |   |   |   |                |   |   |   |   |                     |   |   |   |   |   |   |   |   |   |   |   |                   |   |   |   |   |                     |   |   |   |   |   |   |   |   |   |   |   |                  |   |   |   |   |                     |   |   |   |   |   |   |   |   |   |   |   |                  |   |   |   |   |                     |   |   |   |   |   |   |   |   |   |   |   |                               |   |   |   |   |                     |   |   |   |   |   |   |   |   |   |   |   |                               |   |   |   |   |               |   |   |   |   |   |   |   |   |   |   |   |                             |   |   |   |   |             |   |   |   |   |   |   |   |   |   |   |   |                             |   |   |   |   |               |   |   |   |   |   |   |   |   |   |   |   |          |   |   |   |   |   |   |   |   |   |   |   |   |   |   |   |   |                |   |   |   |   |   |   |   |   |   |   |   |   |   |   |   |   |
|                       |          |      |      |     | VICKY INT3 (Bitmap Collision)   | 0                | 0  | 0   | 0   | 1   | 0                | 0  | 0  | 0  | 0  | 0  | 0  | 0 | 0 | 0 | 0 |   |                   |   |   |   |   |              |   |   |   |   |   |   |   |   |   |   |   |                  |   |   |   |   |                 |   |   |   |   |   |   |   |   |   |   |   |                  |   |   |   |   |           |   |   |   |   |   |   |   |   |   |   |   |                               |   |   |   |   |                   |   |   |   |   |   |   |   |   |   |   |   |                               |   |   |   |   |                    |   |   |   |   |   |   |   |   |   |   |   |                             |   |   |   |   |      |   |   |   |   |   |   |   |   |   |   |   |                             |   |   |   |   |          |   |   |   |   |   |   |   |   |   |   |   |          |   |   |   |   |                |   |   |   |   |   |   |   |   |   |   |   |                |   |   |   |   |                     |   |   |   |   |   |   |   |   |   |   |   |                   |   |   |   |   |                     |   |   |   |   |   |   |   |   |   |   |   |                  |   |   |   |   |                     |   |   |   |   |   |   |   |   |   |   |   |                  |   |   |   |   |                     |   |   |   |   |   |   |   |   |   |   |   |                               |   |   |   |   |                     |   |   |   |   |   |   |   |   |   |   |   |                               |   |   |   |   |               |   |   |   |   |   |   |   |   |   |   |   |                             |   |   |   |   |             |   |   |   |   |   |   |   |   |   |   |   |                             |   |   |   |   |               |   |   |   |   |   |   |   |   |   |   |   |          |   |   |   |   |   |   |   |   |   |   |   |   |   |   |   |   |                |   |   |   |   |   |   |   |   |   |   |   |   |   |   |   |   |
|                       |          |      |      |     | VICKY INT4 (VDMA Interrupt)   | 0                | 0  | 0   | 1   | 0   | 0                | 0  | 0  | 0  | 0  | 0  | 0  | 0 | 0 | 0 | 0 |   |                   |   |   |   |   |              |   |   |   |   |   |   |   |   |   |   |   |                  |   |   |   |   |                 |   |   |   |   |   |   |   |   |   |   |   |                  |   |   |   |   |           |   |   |   |   |   |   |   |   |   |   |   |                               |   |   |   |   |                   |   |   |   |   |   |   |   |   |   |   |   |                               |   |   |   |   |                    |   |   |   |   |   |   |   |   |   |   |   |                             |   |   |   |   |      |   |   |   |   |   |   |   |   |   |   |   |                             |   |   |   |   |          |   |   |   |   |   |   |   |   |   |   |   |          |   |   |   |   |                |   |   |   |   |   |   |   |   |   |   |   |                |   |   |   |   |                     |   |   |   |   |   |   |   |   |   |   |   |                   |   |   |   |   |                     |   |   |   |   |   |   |   |   |   |   |   |                  |   |   |   |   |                     |   |   |   |   |   |   |   |   |   |   |   |                  |   |   |   |   |                     |   |   |   |   |   |   |   |   |   |   |   |                               |   |   |   |   |                     |   |   |   |   |   |   |   |   |   |   |   |                               |   |   |   |   |               |   |   |   |   |   |   |   |   |   |   |   |                             |   |   |   |   |             |   |   |   |   |   |   |   |   |   |   |   |                             |   |   |   |   |               |   |   |   |   |   |   |   |   |   |   |   |          |   |   |   |   |   |   |   |   |   |   |   |   |   |   |   |   |                |   |   |   |   |   |   |   |   |   |   |   |   |   |   |   |   |
|                       |          |      |      |     | VICKY INT5 (Tile Collision)   | 0                | 0  | 1   | 0   | 0   | 0                | 0  | 0  | 0  | 0  | 0  | 0  | 0 | 0 | 0 | 0 |   |                   |   |   |   |   |              |   |   |   |   |   |   |   |   |   |   |   |                  |   |   |   |   |                 |   |   |   |   |   |   |   |   |   |   |   |                  |   |   |   |   |           |   |   |   |   |   |   |   |   |   |   |   |                               |   |   |   |   |                   |   |   |   |   |   |   |   |   |   |   |   |                               |   |   |   |   |                    |   |   |   |   |   |   |   |   |   |   |   |                             |   |   |   |   |      |   |   |   |   |   |   |   |   |   |   |   |                             |   |   |   |   |          |   |   |   |   |   |   |   |   |   |   |   |          |   |   |   |   |                |   |   |   |   |   |   |   |   |   |   |   |                |   |   |   |   |                     |   |   |   |   |   |   |   |   |   |   |   |                   |   |   |   |   |                     |   |   |   |   |   |   |   |   |   |   |   |                  |   |   |   |   |                     |   |   |   |   |   |   |   |   |   |   |   |                  |   |   |   |   |                     |   |   |   |   |   |   |   |   |   |   |   |                               |   |   |   |   |                     |   |   |   |   |   |   |   |   |   |   |   |                               |   |   |   |   |               |   |   |   |   |   |   |   |   |   |   |   |                             |   |   |   |   |             |   |   |   |   |   |   |   |   |   |   |   |                             |   |   |   |   |               |   |   |   |   |   |   |   |   |   |   |   |          |   |   |   |   |   |   |   |   |   |   |   |   |   |   |   |   |                |   |   |   |   |   |   |   |   |   |   |   |   |   |   |   |   |
|                       |          |      |      |     | Reserved  | 0                | 1  | 0   | 0   | 0   | 0                | 0  | 0  | 0  | 0  | 0  | 0  | 0 | 0 | 0 | 0 |   |                   |   |   |   |   |              |   |   |   |   |   |   |   |   |   |   |   |                  |   |   |   |   |                 |   |   |   |   |   |   |   |   |   |   |   |                  |   |   |   |   |           |   |   |   |   |   |   |   |   |   |   |   |                               |   |   |   |   |                   |   |   |   |   |   |   |   |   |   |   |   |                               |   |   |   |   |                    |   |   |   |   |   |   |   |   |   |   |   |                             |   |   |   |   |      |   |   |   |   |   |   |   |   |   |   |   |                             |   |   |   |   |          |   |   |   |   |   |   |   |   |   |   |   |          |   |   |   |   |                |   |   |   |   |   |   |   |   |   |   |   |                |   |   |   |   |                     |   |   |   |   |   |   |   |   |   |   |   |                   |   |   |   |   |                     |   |   |   |   |   |   |   |   |   |   |   |                  |   |   |   |   |                     |   |   |   |   |   |   |   |   |   |   |   |                  |   |   |   |   |                     |   |   |   |   |   |   |   |   |   |   |   |                               |   |   |   |   |                     |   |   |   |   |   |   |   |   |   |   |   |                               |   |   |   |   |               |   |   |   |   |   |   |   |   |   |   |   |                             |   |   |   |   |             |   |   |   |   |   |   |   |   |   |   |   |                             |   |   |   |   |               |   |   |   |   |   |   |   |   |   |   |   |          |   |   |   |   |   |   |   |   |   |   |   |   |   |   |   |   |                |   |   |   |   |   |   |   |   |   |   |   |   |   |   |   |   |
|                       |          |      |      |     | VICKY Hot-Plug  | 1                | 0  | 0   | 0   | 0   | 0                | 0  | 0  | 0  | 0  | 0  | 0  | 0 | 0 | 0 | 0 |   |                   |   |   |   |   |              |   |   |   |   |   |   |   |   |   |   |   |                  |   |   |   |   |                 |   |   |   |   |   |   |   |   |   |   |   |                  |   |   |   |   |           |   |   |   |   |   |   |   |   |   |   |   |                               |   |   |   |   |                   |   |   |   |   |   |   |   |   |   |   |   |                               |   |   |   |   |                    |   |   |   |   |   |   |   |   |   |   |   |                             |   |   |   |   |      |   |   |   |   |   |   |   |   |   |   |   |                             |   |   |   |   |          |   |   |   |   |   |   |   |   |   |   |   |          |   |   |   |   |                |   |   |   |   |   |   |   |   |   |   |   |                |   |   |   |   |                     |   |   |   |   |   |   |   |   |   |   |   |                   |   |   |   |   |                     |   |   |   |   |   |   |   |   |   |   |   |                  |   |   |   |   |                     |   |   |   |   |   |   |   |   |   |   |   |                  |   |   |   |   |                     |   |   |   |   |   |   |   |   |   |   |   |                               |   |   |   |   |                     |   |   |   |   |   |   |   |   |   |   |   |                               |   |   |   |   |               |   |   |   |   |   |   |   |   |   |   |   |                             |   |   |   |   |             |   |   |   |   |   |   |   |   |   |   |   |                             |   |   |   |   |               |   |   |   |   |   |   |   |   |   |   |   |          |   |   |   |   |   |   |   |   |   |   |   |   |   |   |   |   |                |   |   |   |   |   |   |   |   |   |   |   |   |   |   |   |   |
|                       |          |      |      |     | Value @ Reset: 0x0000   |                  |    |     |     |   |                  |    |    |    |    |    |    |   |   |   |   |   |                   |   |   |   |   |              |   |   |   |   |   |   |   |   |   |   |   |                  |   |   |   |   |                 |   |   |   |   |   |   |   |   |   |   |   |                  |   |   |   |   |           |   |   |   |   |   |   |   |   |   |   |   |                               |   |   |   |   |                   |   |   |   |   |   |   |   |   |   |   |   |                               |   |   |   |   |                    |   |   |   |   |   |   |   |   |   |   |   |                             |   |   |   |   |      |   |   |   |   |   |   |   |   |   |   |   |                             |   |   |   |   |          |   |   |   |   |   |   |   |   |   |   |   |          |   |   |   |   |                |   |   |   |   |   |   |   |   |   |   |   |                |   |   |   |   |                     |   |   |   |   |   |   |   |   |   |   |   |                   |   |   |   |   |                     |   |   |   |   |   |   |   |   |   |   |   |                  |   |   |   |   |                     |   |   |   |   |   |   |   |   |   |   |   |                  |   |   |   |   |                     |   |   |   |   |   |   |   |   |   |   |   |                               |   |   |   |   |                     |   |   |   |   |   |   |   |   |   |   |   |                               |   |   |   |   |               |   |   |   |   |   |   |   |   |   |   |   |                             |   |   |   |   |             |   |   |   |   |   |   |   |   |   |   |   |                             |   |   |   |   |               |   |   |   |   |   |   |   |   |   |   |   |          |   |   |   |   |   |   |   |   |   |   |   |   |   |   |   |   |                |   |   |   |   |   |   |   |   |   |   |   |   |   |   |   |   |
|                       |          |      |      |     | 0x0102  |                  | 16 | I/O | R/W | <b>Interrupt Pending Register Group 1 (GAVIN)</b>   |                  |    |    |    |    |    |    |   |   |   |   |   |                   |   |   |   |   |              |   |   |   |   |   |   |   |   |   |   |   |                  |   |   |   |   |                 |   |   |   |   |   |   |   |   |   |   |   |                  |   |   |   |   |           |   |   |   |   |   |   |   |   |   |   |   |                               |   |   |   |   |                   |   |   |   |   |   |   |   |   |   |   |   |                               |   |   |   |   |                    |   |   |   |   |   |   |   |   |   |   |   |                             |   |   |   |   |      |   |   |   |   |   |   |   |   |   |   |   |                             |   |   |   |   |          |   |   |   |   |   |   |   |   |   |   |   |          |   |   |   |   |                |   |   |   |   |   |   |   |   |   |   |   |                |   |   |   |   |                     |   |   |   |   |   |   |   |   |   |   |   |                   |   |   |   |   |                     |   |   |   |   |   |   |   |   |   |   |   |                  |   |   |   |   |                     |   |   |   |   |   |   |   |   |   |   |   |                  |   |   |   |   |                     |   |   |   |   |   |   |   |   |   |   |   |                               |   |   |   |   |                     |   |   |   |   |   |   |   |   |   |   |   |                               |   |   |   |   |               |   |   |   |   |   |   |   |   |   |   |   |                             |   |   |   |   |             |   |   |   |   |   |   |   |   |   |   |   |                             |   |   |   |   |               |   |   |   |   |   |   |   |   |   |   |   |          |   |   |   |   |   |   |   |   |   |   |   |   |   |   |   |   |                |   |   |   |   |   |   |   |   |   |   |   |   |   |   |   |   |
|                       |          |      |      |     |   |                  |    |     |     | <table border="1"> <thead> <tr> <th>Interrupt Source</th> <th>15</th><th>14</th><th>13</th><th>12</th><th>11</th><th>10</th><th>9</th><th>8</th><th>7</th><th>6</th><th>5</th><th>4</th><th>3</th><th>2</th><th>1</th><th>0</th> </tr> </thead> <tbody> <tr> <td>PS2 Keyboard</td> <td>0</td><td>0</td><td>0</td><td>0</td><td>0</td><td>0</td><td>0</td><td>0</td><td>0</td><td>0</td><td>0</td><td>0</td><td>0</td><td>0</td><td>0</td><td>1</td> </tr> <tr> <td>A2560K Keyboard</td> <td>0</td><td>0</td><td>0</td><td>0</td><td>0</td><td>0</td><td>0</td><td>0</td><td>0</td><td>0</td><td>0</td><td>0</td><td>0</td><td>0</td><td>1</td><td>0</td> </tr> <tr> <td>PS2 Mouse</td> <td>0</td><td>0</td><td>0</td><td>0</td><td>0</td><td>0</td><td>0</td><td>0</td><td>0</td><td>0</td><td>0</td><td>0</td><td>0</td><td>1</td><td>0</td><td>0</td> </tr> <tr> <td>COM1</td> <td>0</td><td>0</td><td>0</td><td>0</td><td>0</td><td>0</td><td>0</td><td>0</td><td>0</td><td>0</td><td>0</td><td>0</td><td>1</td><td>0</td><td>0</td><td>0</td> </tr> <tr> <td>COM2</td> <td>0</td><td>0</td><td>0</td><td>0</td><td>0</td><td>0</td><td>0</td><td>0</td><td>0</td><td>0</td><td>0</td><td>1</td><td>0</td><td>0</td><td>0</td><td>0</td> </tr> <tr> <td>LPT1</td> <td>0</td><td>0</td><td>0</td><td>0</td><td>0</td><td>0</td><td>0</td><td>0</td><td>0</td><td>0</td><td>1</td><td>0</td><td>0</td><td>0</td><td>0</td><td>0</td> </tr> <tr> <td>FDC</td> <td>0</td><td>0</td><td>0</td><td>0</td><td>0</td><td>0</td><td>0</td><td>0</td><td>0</td><td>1</td><td>0</td><td>0</td><td>0</td><td>0</td><td>0</td><td>0</td> </tr> <tr> <td>MPU-401 (MIDI)</td> <td>0</td><td>0</td><td>0</td><td>0</td><td>0</td><td>0</td><td>0</td><td>0</td><td>1</td><td>0</td><td>0</td><td>0</td><td>0</td><td>0</td><td>0</td><td>0</td> </tr> <tr> <td>Timer 0 (CPU Clock)</td> <td>0</td><td>0</td><td>0</td><td>0</td><td>0</td><td>0</td><td>0</td><td>1</td><td>0</td><td>0</td><td>0</td><td>0</td><td>0</td><td>0</td><td>0</td><td>0</td> </tr> <tr> <td>Timer 1 (CPU Clock)</td> <td>0</td><td>0</td><td>0</td><td>0</td><td>0</td><td>0</td><td>1</td><td>0</td><td>0</td><td>0</td><td>0</td><td>0</td><td>0</td><td>0</td><td>0</td><td>0</td> </tr> <tr> <td>Timer 2 (CPU Clock)</td> <td>0</td><td>0</td><td>0</td><td>0</td><td>0</td><td>1</td><td>0</td><td>0</td><td>0</td><td>0</td><td>0</td><td>0</td><td>0</td><td>0</td><td>0</td><td>0</td> </tr> <tr> <td>Timer 3 (SOF Clock)</td> <td>0</td><td>0</td><td>0</td><td>0</td><td>1</td><td>0</td><td>0</td><td>0</td><td>0</td><td>0</td><td>0</td><td>0</td><td>0</td><td>0</td><td>0</td><td>0</td> </tr> <tr> <td>Timer 4 (SOF Clock)</td> <td>0</td><td>0</td><td>0</td><td>1</td><td>0</td><td>0</td><td>0</td><td>0</td><td>0</td><td>0</td><td>0</td><td>0</td><td>0</td><td>0</td><td>0</td><td>0</td> </tr> <tr> <td>Reserved</td> <td>0</td><td>0</td><td>0</td><td>0</td><td>0</td><td>0</td><td>0</td><td>0</td><td>0</td><td>0</td><td>0</td><td>0</td><td>0</td><td>0</td><td>0</td><td>0</td> </tr> <tr> <td>LAN9221 IRQ</td> <td>0</td><td>1</td><td>0</td><td>0</td><td>0</td><td>0</td><td>0</td><td>0</td><td>0</td><td>0</td><td>0</td><td>0</td><td>0</td><td>0</td><td>0</td><td>0</td> </tr> <tr> <td>RTC</td> <td>1</td><td>0</td><td>0</td><td>0</td><td>0</td><td>0</td><td>0</td><td>0</td><td>0</td><td>0</td><td>0</td><td>0</td><td>0</td><td>0</td><td>0</td><td>0</td> </tr> </tbody> </table> | Interrupt Source | 15 | 14 | 13 | 12 | 11 | 10 | 9 | 8 | 7 | 6 | 5 | 4                 | 3 | 2 | 1 | 0 | PS2 Keyboard | 0 | 0 | 0 | 0 | 0 | 0 | 0 | 0 | 0 | 0 | 0 | 0                | 0 | 0 | 0 | 1 | A2560K Keyboard | 0 | 0 | 0 | 0 | 0 | 0 | 0 | 0 | 0 | 0 | 0 | 0                | 0 | 0 | 1 | 0 | PS2 Mouse | 0 | 0 | 0 | 0 | 0 | 0 | 0 | 0 | 0 | 0 | 0 | 0                             | 0 | 1 | 0 | 0 | COM1              | 0 | 0 | 0 | 0 | 0 | 0 | 0 | 0 | 0 | 0 | 0 | 0                             | 1 | 0 | 0 | 0 | COM2               | 0 | 0 | 0 | 0 | 0 | 0 | 0 | 0 | 0 | 0 | 0 | 1                           | 0 | 0 | 0 | 0 | LPT1 | 0 | 0 | 0 | 0 | 0 | 0 | 0 | 0 | 0 | 0 | 1 | 0                           | 0 | 0 | 0 | 0 | FDC      | 0 | 0 | 0 | 0 | 0 | 0 | 0 | 0 | 0 | 1 | 0 | 0        | 0 | 0 | 0 | 0 | MPU-401 (MIDI) | 0 | 0 | 0 | 0 | 0 | 0 | 0 | 0 | 1 | 0 | 0 | 0              | 0 | 0 | 0 | 0 | Timer 0 (CPU Clock) | 0 | 0 | 0 | 0 | 0 | 0 | 0 | 1 | 0 | 0 | 0 | 0                 | 0 | 0 | 0 | 0 | Timer 1 (CPU Clock) | 0 | 0 | 0 | 0 | 0 | 0 | 1 | 0 | 0 | 0 | 0 | 0                | 0 | 0 | 0 | 0 | Timer 2 (CPU Clock) | 0 | 0 | 0 | 0 | 0 | 1 | 0 | 0 | 0 | 0 | 0 | 0                | 0 | 0 | 0 | 0 | Timer 3 (SOF Clock) | 0 | 0 | 0 | 0 | 1 | 0 | 0 | 0 | 0 | 0 | 0 | 0                             | 0 | 0 | 0 | 0 | Timer 4 (SOF Clock) | 0 | 0 | 0 | 1 | 0 | 0 | 0 | 0 | 0 | 0 | 0 | 0                             | 0 | 0 | 0 | 0 | Reserved      | 0 | 0 | 0 | 0 | 0 | 0 | 0 | 0 | 0 | 0 | 0 | 0                           | 0 | 0 | 0 | 0 | LAN9221 IRQ | 0 | 1 | 0 | 0 | 0 | 0 | 0 | 0 | 0 | 0 | 0 | 0                           | 0 | 0 | 0 | 0 | RTC           | 1 | 0 | 0 | 0 | 0 | 0 | 0 | 0 | 0 | 0 | 0 | 0        | 0 | 0 | 0 | 0 |   |   |   |   |   |   |   |   |   |   |   |   |                |   |   |   |   |   |   |   |   |   |   |   |   |   |   |   |   |
|                       |          |      |      |     |   |                  |    |     |     | Interrupt Source  | 15               | 14 | 13 | 12 | 11 | 10 | 9  | 8 | 7 | 6 | 5 | 4 | 3                 | 2 | 1 | 0 |   |              |   |   |   |   |   |   |   |   |   |   |   |                  |   |   |   |   |                 |   |   |   |   |   |   |   |   |   |   |   |                  |   |   |   |   |           |   |   |   |   |   |   |   |   |   |   |   |                               |   |   |   |   |                   |   |   |   |   |   |   |   |   |   |   |   |                               |   |   |   |   |                    |   |   |   |   |   |   |   |   |   |   |   |                             |   |   |   |   |      |   |   |   |   |   |   |   |   |   |   |   |                             |   |   |   |   |          |   |   |   |   |   |   |   |   |   |   |   |          |   |   |   |   |                |   |   |   |   |   |   |   |   |   |   |   |                |   |   |   |   |                     |   |   |   |   |   |   |   |   |   |   |   |                   |   |   |   |   |                     |   |   |   |   |   |   |   |   |   |   |   |                  |   |   |   |   |                     |   |   |   |   |   |   |   |   |   |   |   |                  |   |   |   |   |                     |   |   |   |   |   |   |   |   |   |   |   |                               |   |   |   |   |                     |   |   |   |   |   |   |   |   |   |   |   |                               |   |   |   |   |               |   |   |   |   |   |   |   |   |   |   |   |                             |   |   |   |   |             |   |   |   |   |   |   |   |   |   |   |   |                             |   |   |   |   |               |   |   |   |   |   |   |   |   |   |   |   |          |   |   |   |   |   |   |   |   |   |   |   |   |   |   |   |   |                |   |   |   |   |   |   |   |   |   |   |   |   |   |   |   |   |
|                       |          |      |      |     |   |                  |    |     |     | PS2 Keyboard  | 0                | 0  | 0  | 0  | 0  | 0  | 0  | 0 | 0 | 0 | 0 | 0 | 0                 | 0 | 0 | 1 |   |              |   |   |   |   |   |   |   |   |   |   |   |                  |   |   |   |   |                 |   |   |   |   |   |   |   |   |   |   |   |                  |   |   |   |   |           |   |   |   |   |   |   |   |   |   |   |   |                               |   |   |   |   |                   |   |   |   |   |   |   |   |   |   |   |   |                               |   |   |   |   |                    |   |   |   |   |   |   |   |   |   |   |   |                             |   |   |   |   |      |   |   |   |   |   |   |   |   |   |   |   |                             |   |   |   |   |          |   |   |   |   |   |   |   |   |   |   |   |          |   |   |   |   |                |   |   |   |   |   |   |   |   |   |   |   |                |   |   |   |   |                     |   |   |   |   |   |   |   |   |   |   |   |                   |   |   |   |   |                     |   |   |   |   |   |   |   |   |   |   |   |                  |   |   |   |   |                     |   |   |   |   |   |   |   |   |   |   |   |                  |   |   |   |   |                     |   |   |   |   |   |   |   |   |   |   |   |                               |   |   |   |   |                     |   |   |   |   |   |   |   |   |   |   |   |                               |   |   |   |   |               |   |   |   |   |   |   |   |   |   |   |   |                             |   |   |   |   |             |   |   |   |   |   |   |   |   |   |   |   |                             |   |   |   |   |               |   |   |   |   |   |   |   |   |   |   |   |          |   |   |   |   |   |   |   |   |   |   |   |   |   |   |   |   |                |   |   |   |   |   |   |   |   |   |   |   |   |   |   |   |   |
|                       |          |      |      |     |   |                  |    |     |     | A2560K Keyboard   | 0                | 0  | 0  | 0  | 0  | 0  | 0  | 0 | 0 | 0 | 0 | 0 | 0                 | 0 | 1 | 0 |   |              |   |   |   |   |   |   |   |   |   |   |   |                  |   |   |   |   |                 |   |   |   |   |   |   |   |   |   |   |   |                  |   |   |   |   |           |   |   |   |   |   |   |   |   |   |   |   |                               |   |   |   |   |                   |   |   |   |   |   |   |   |   |   |   |   |                               |   |   |   |   |                    |   |   |   |   |   |   |   |   |   |   |   |                             |   |   |   |   |      |   |   |   |   |   |   |   |   |   |   |   |                             |   |   |   |   |          |   |   |   |   |   |   |   |   |   |   |   |          |   |   |   |   |                |   |   |   |   |   |   |   |   |   |   |   |                |   |   |   |   |                     |   |   |   |   |   |   |   |   |   |   |   |                   |   |   |   |   |                     |   |   |   |   |   |   |   |   |   |   |   |                  |   |   |   |   |                     |   |   |   |   |   |   |   |   |   |   |   |                  |   |   |   |   |                     |   |   |   |   |   |   |   |   |   |   |   |                               |   |   |   |   |                     |   |   |   |   |   |   |   |   |   |   |   |                               |   |   |   |   |               |   |   |   |   |   |   |   |   |   |   |   |                             |   |   |   |   |             |   |   |   |   |   |   |   |   |   |   |   |                             |   |   |   |   |               |   |   |   |   |   |   |   |   |   |   |   |          |   |   |   |   |   |   |   |   |   |   |   |   |   |   |   |   |                |   |   |   |   |   |   |   |   |   |   |   |   |   |   |   |   |
| PS2 Mouse             | 0        | 0    | 0    | 0   |   |                  |    |     |     | 0   | 0                | 0  | 0  | 0  | 0  | 0  | 0  | 0 | 1 | 0 | 0 |   |                   |   |   |   |   |              |   |   |   |   |   |   |   |   |   |   |   |                  |   |   |   |   |                 |   |   |   |   |   |   |   |   |   |   |   |                  |   |   |   |   |           |   |   |   |   |   |   |   |   |   |   |   |                               |   |   |   |   |                   |   |   |   |   |   |   |   |   |   |   |   |                               |   |   |   |   |                    |   |   |   |   |   |   |   |   |   |   |   |                             |   |   |   |   |      |   |   |   |   |   |   |   |   |   |   |   |                             |   |   |   |   |          |   |   |   |   |   |   |   |   |   |   |   |          |   |   |   |   |                |   |   |   |   |   |   |   |   |   |   |   |                |   |   |   |   |                     |   |   |   |   |   |   |   |   |   |   |   |                   |   |   |   |   |                     |   |   |   |   |   |   |   |   |   |   |   |                  |   |   |   |   |                     |   |   |   |   |   |   |   |   |   |   |   |                  |   |   |   |   |                     |   |   |   |   |   |   |   |   |   |   |   |                               |   |   |   |   |                     |   |   |   |   |   |   |   |   |   |   |   |                               |   |   |   |   |               |   |   |   |   |   |   |   |   |   |   |   |                             |   |   |   |   |             |   |   |   |   |   |   |   |   |   |   |   |                             |   |   |   |   |               |   |   |   |   |   |   |   |   |   |   |   |          |   |   |   |   |   |   |   |   |   |   |   |   |   |   |   |   |                |   |   |   |   |   |   |   |   |   |   |   |   |   |   |   |   |
| COM1                  | 0        | 0    | 0    | 0   |   |                  |    |     |     | 0   | 0                | 0  | 0  | 0  | 0  | 0  | 0  | 1 | 0 | 0 | 0 |   |                   |   |   |   |   |              |   |   |   |   |   |   |   |   |   |   |   |                  |   |   |   |   |                 |   |   |   |   |   |   |   |   |   |   |   |                  |   |   |   |   |           |   |   |   |   |   |   |   |   |   |   |   |                               |   |   |   |   |                   |   |   |   |   |   |   |   |   |   |   |   |                               |   |   |   |   |                    |   |   |   |   |   |   |   |   |   |   |   |                             |   |   |   |   |      |   |   |   |   |   |   |   |   |   |   |   |                             |   |   |   |   |          |   |   |   |   |   |   |   |   |   |   |   |          |   |   |   |   |                |   |   |   |   |   |   |   |   |   |   |   |                |   |   |   |   |                     |   |   |   |   |   |   |   |   |   |   |   |                   |   |   |   |   |                     |   |   |   |   |   |   |   |   |   |   |   |                  |   |   |   |   |                     |   |   |   |   |   |   |   |   |   |   |   |                  |   |   |   |   |                     |   |   |   |   |   |   |   |   |   |   |   |                               |   |   |   |   |                     |   |   |   |   |   |   |   |   |   |   |   |                               |   |   |   |   |               |   |   |   |   |   |   |   |   |   |   |   |                             |   |   |   |   |             |   |   |   |   |   |   |   |   |   |   |   |                             |   |   |   |   |               |   |   |   |   |   |   |   |   |   |   |   |          |   |   |   |   |   |   |   |   |   |   |   |   |   |   |   |   |                |   |   |   |   |   |   |   |   |   |   |   |   |   |   |   |   |
| COM2                  | 0        | 0    | 0    | 0   |   |                  |    |     |     | 0   | 0                | 0  | 0  | 0  | 0  | 0  | 1  | 0 | 0 | 0 | 0 |   |                   |   |   |   |   |              |   |   |   |   |   |   |   |   |   |   |   |                  |   |   |   |   |                 |   |   |   |   |   |   |   |   |   |   |   |                  |   |   |   |   |           |   |   |   |   |   |   |   |   |   |   |   |                               |   |   |   |   |                   |   |   |   |   |   |   |   |   |   |   |   |                               |   |   |   |   |                    |   |   |   |   |   |   |   |   |   |   |   |                             |   |   |   |   |      |   |   |   |   |   |   |   |   |   |   |   |                             |   |   |   |   |          |   |   |   |   |   |   |   |   |   |   |   |          |   |   |   |   |                |   |   |   |   |   |   |   |   |   |   |   |                |   |   |   |   |                     |   |   |   |   |   |   |   |   |   |   |   |                   |   |   |   |   |                     |   |   |   |   |   |   |   |   |   |   |   |                  |   |   |   |   |                     |   |   |   |   |   |   |   |   |   |   |   |                  |   |   |   |   |                     |   |   |   |   |   |   |   |   |   |   |   |                               |   |   |   |   |                     |   |   |   |   |   |   |   |   |   |   |   |                               |   |   |   |   |               |   |   |   |   |   |   |   |   |   |   |   |                             |   |   |   |   |             |   |   |   |   |   |   |   |   |   |   |   |                             |   |   |   |   |               |   |   |   |   |   |   |   |   |   |   |   |          |   |   |   |   |   |   |   |   |   |   |   |   |   |   |   |   |                |   |   |   |   |   |   |   |   |   |   |   |   |   |   |   |   |
| LPT1                  | 0        | 0    | 0    | 0   |   |                  |    |     |     | 0   | 0                | 0  | 0  | 0  | 0  | 1  | 0  | 0 | 0 | 0 | 0 |   |                   |   |   |   |   |              |   |   |   |   |   |   |   |   |   |   |   |                  |   |   |   |   |                 |   |   |   |   |   |   |   |   |   |   |   |                  |   |   |   |   |           |   |   |   |   |   |   |   |   |   |   |   |                               |   |   |   |   |                   |   |   |   |   |   |   |   |   |   |   |   |                               |   |   |   |   |                    |   |   |   |   |   |   |   |   |   |   |   |                             |   |   |   |   |      |   |   |   |   |   |   |   |   |   |   |   |                             |   |   |   |   |          |   |   |   |   |   |   |   |   |   |   |   |          |   |   |   |   |                |   |   |   |   |   |   |   |   |   |   |   |                |   |   |   |   |                     |   |   |   |   |   |   |   |   |   |   |   |                   |   |   |   |   |                     |   |   |   |   |   |   |   |   |   |   |   |                  |   |   |   |   |                     |   |   |   |   |   |   |   |   |   |   |   |                  |   |   |   |   |                     |   |   |   |   |   |   |   |   |   |   |   |                               |   |   |   |   |                     |   |   |   |   |   |   |   |   |   |   |   |                               |   |   |   |   |               |   |   |   |   |   |   |   |   |   |   |   |                             |   |   |   |   |             |   |   |   |   |   |   |   |   |   |   |   |                             |   |   |   |   |               |   |   |   |   |   |   |   |   |   |   |   |          |   |   |   |   |   |   |   |   |   |   |   |   |   |   |   |   |                |   |   |   |   |   |   |   |   |   |   |   |   |   |   |   |   |
| FDC                   | 0        | 0    | 0    | 0   |   |                  |    |     |     | 0   | 0                | 0  | 0  | 0  | 1  | 0  | 0  | 0 | 0 | 0 | 0 |   |                   |   |   |   |   |              |   |   |   |   |   |   |   |   |   |   |   |                  |   |   |   |   |                 |   |   |   |   |   |   |   |   |   |   |   |                  |   |   |   |   |           |   |   |   |   |   |   |   |   |   |   |   |                               |   |   |   |   |                   |   |   |   |   |   |   |   |   |   |   |   |                               |   |   |   |   |                    |   |   |   |   |   |   |   |   |   |   |   |                             |   |   |   |   |      |   |   |   |   |   |   |   |   |   |   |   |                             |   |   |   |   |          |   |   |   |   |   |   |   |   |   |   |   |          |   |   |   |   |                |   |   |   |   |   |   |   |   |   |   |   |                |   |   |   |   |                     |   |   |   |   |   |   |   |   |   |   |   |                   |   |   |   |   |                     |   |   |   |   |   |   |   |   |   |   |   |                  |   |   |   |   |                     |   |   |   |   |   |   |   |   |   |   |   |                  |   |   |   |   |                     |   |   |   |   |   |   |   |   |   |   |   |                               |   |   |   |   |                     |   |   |   |   |   |   |   |   |   |   |   |                               |   |   |   |   |               |   |   |   |   |   |   |   |   |   |   |   |                             |   |   |   |   |             |   |   |   |   |   |   |   |   |   |   |   |                             |   |   |   |   |               |   |   |   |   |   |   |   |   |   |   |   |          |   |   |   |   |   |   |   |   |   |   |   |   |   |   |   |   |                |   |   |   |   |   |   |   |   |   |   |   |   |   |   |   |   |
| MPU-401 (MIDI)        | 0        | 0    | 0    | 0   |   |                  |    |     |     | 0   | 0                | 0  | 0  | 1  | 0  | 0  | 0  | 0 | 0 | 0 | 0 |   |                   |   |   |   |   |              |   |   |   |   |   |   |   |   |   |   |   |                  |   |   |   |   |                 |   |   |   |   |   |   |   |   |   |   |   |                  |   |   |   |   |           |   |   |   |   |   |   |   |   |   |   |   |                               |   |   |   |   |                   |   |   |   |   |   |   |   |   |   |   |   |                               |   |   |   |   |                    |   |   |   |   |   |   |   |   |   |   |   |                             |   |   |   |   |      |   |   |   |   |   |   |   |   |   |   |   |                             |   |   |   |   |          |   |   |   |   |   |   |   |   |   |   |   |          |   |   |   |   |                |   |   |   |   |   |   |   |   |   |   |   |                |   |   |   |   |                     |   |   |   |   |   |   |   |   |   |   |   |                   |   |   |   |   |                     |   |   |   |   |   |   |   |   |   |   |   |                  |   |   |   |   |                     |   |   |   |   |   |   |   |   |   |   |   |                  |   |   |   |   |                     |   |   |   |   |   |   |   |   |   |   |   |                               |   |   |   |   |                     |   |   |   |   |   |   |   |   |   |   |   |                               |   |   |   |   |               |   |   |   |   |   |   |   |   |   |   |   |                             |   |   |   |   |             |   |   |   |   |   |   |   |   |   |   |   |                             |   |   |   |   |               |   |   |   |   |   |   |   |   |   |   |   |          |   |   |   |   |   |   |   |   |   |   |   |   |   |   |   |   |                |   |   |   |   |   |   |   |   |   |   |   |   |   |   |   |   |
| Timer 0 (CPU Clock)   | 0        | 0    | 0    | 0   |   |                  |    |     |     | 0   | 0                | 0  | 1  | 0  | 0  | 0  | 0  | 0 | 0 | 0 | 0 |   |                   |   |   |   |   |              |   |   |   |   |   |   |   |   |   |   |   |                  |   |   |   |   |                 |   |   |   |   |   |   |   |   |   |   |   |                  |   |   |   |   |           |   |   |   |   |   |   |   |   |   |   |   |                               |   |   |   |   |                   |   |   |   |   |   |   |   |   |   |   |   |                               |   |   |   |   |                    |   |   |   |   |   |   |   |   |   |   |   |                             |   |   |   |   |      |   |   |   |   |   |   |   |   |   |   |   |                             |   |   |   |   |          |   |   |   |   |   |   |   |   |   |   |   |          |   |   |   |   |                |   |   |   |   |   |   |   |   |   |   |   |                |   |   |   |   |                     |   |   |   |   |   |   |   |   |   |   |   |                   |   |   |   |   |                     |   |   |   |   |   |   |   |   |   |   |   |                  |   |   |   |   |                     |   |   |   |   |   |   |   |   |   |   |   |                  |   |   |   |   |                     |   |   |   |   |   |   |   |   |   |   |   |                               |   |   |   |   |                     |   |   |   |   |   |   |   |   |   |   |   |                               |   |   |   |   |               |   |   |   |   |   |   |   |   |   |   |   |                             |   |   |   |   |             |   |   |   |   |   |   |   |   |   |   |   |                             |   |   |   |   |               |   |   |   |   |   |   |   |   |   |   |   |          |   |   |   |   |   |   |   |   |   |   |   |   |   |   |   |   |                |   |   |   |   |   |   |   |   |   |   |   |   |   |   |   |   |
| Timer 1 (CPU Clock)   | 0        | 0    | 0    | 0   |   |                  |    |     |     | 0   | 0                | 1  | 0  | 0  | 0  | 0  | 0  | 0 | 0 | 0 | 0 |   |                   |   |   |   |   |              |   |   |   |   |   |   |   |   |   |   |   |                  |   |   |   |   |                 |   |   |   |   |   |   |   |   |   |   |   |                  |   |   |   |   |           |   |   |   |   |   |   |   |   |   |   |   |                               |   |   |   |   |                   |   |   |   |   |   |   |   |   |   |   |   |                               |   |   |   |   |                    |   |   |   |   |   |   |   |   |   |   |   |                             |   |   |   |   |      |   |   |   |   |   |   |   |   |   |   |   |                             |   |   |   |   |          |   |   |   |   |   |   |   |   |   |   |   |          |   |   |   |   |                |   |   |   |   |   |   |   |   |   |   |   |                |   |   |   |   |                     |   |   |   |   |   |   |   |   |   |   |   |                   |   |   |   |   |                     |   |   |   |   |   |   |   |   |   |   |   |                  |   |   |   |   |                     |   |   |   |   |   |   |   |   |   |   |   |                  |   |   |   |   |                     |   |   |   |   |   |   |   |   |   |   |   |                               |   |   |   |   |                     |   |   |   |   |   |   |   |   |   |   |   |                               |   |   |   |   |               |   |   |   |   |   |   |   |   |   |   |   |                             |   |   |   |   |             |   |   |   |   |   |   |   |   |   |   |   |                             |   |   |   |   |               |   |   |   |   |   |   |   |   |   |   |   |          |   |   |   |   |   |   |   |   |   |   |   |   |   |   |   |   |                |   |   |   |   |   |   |   |   |   |   |   |   |   |   |   |   |
| Timer 2 (CPU Clock)   | 0        | 0    | 0    | 0   |   |                  |    |     |     | 0   | 1                | 0  | 0  | 0  | 0  | 0  | 0  | 0 | 0 | 0 | 0 |   |                   |   |   |   |   |              |   |   |   |   |   |   |   |   |   |   |   |                  |   |   |   |   |                 |   |   |   |   |   |   |   |   |   |   |   |                  |   |   |   |   |           |   |   |   |   |   |   |   |   |   |   |   |                               |   |   |   |   |                   |   |   |   |   |   |   |   |   |   |   |   |                               |   |   |   |   |                    |   |   |   |   |   |   |   |   |   |   |   |                             |   |   |   |   |      |   |   |   |   |   |   |   |   |   |   |   |                             |   |   |   |   |          |   |   |   |   |   |   |   |   |   |   |   |          |   |   |   |   |                |   |   |   |   |   |   |   |   |   |   |   |                |   |   |   |   |                     |   |   |   |   |   |   |   |   |   |   |   |                   |   |   |   |   |                     |   |   |   |   |   |   |   |   |   |   |   |                  |   |   |   |   |                     |   |   |   |   |   |   |   |   |   |   |   |                  |   |   |   |   |                     |   |   |   |   |   |   |   |   |   |   |   |                               |   |   |   |   |                     |   |   |   |   |   |   |   |   |   |   |   |                               |   |   |   |   |               |   |   |   |   |   |   |   |   |   |   |   |                             |   |   |   |   |             |   |   |   |   |   |   |   |   |   |   |   |                             |   |   |   |   |               |   |   |   |   |   |   |   |   |   |   |   |          |   |   |   |   |   |   |   |   |   |   |   |   |   |   |   |   |                |   |   |   |   |   |   |   |   |   |   |   |   |   |   |   |   |
| Timer 3 (SOF Clock)   | 0        | 0    | 0    | 0   |   |                  |    |     |     | 1   | 0                | 0  | 0  | 0  | 0  | 0  | 0  | 0 | 0 | 0 | 0 |   |                   |   |   |   |   |              |   |   |   |   |   |   |   |   |   |   |   |                  |   |   |   |   |                 |   |   |   |   |   |   |   |   |   |   |   |                  |   |   |   |   |           |   |   |   |   |   |   |   |   |   |   |   |                               |   |   |   |   |                   |   |   |   |   |   |   |   |   |   |   |   |                               |   |   |   |   |                    |   |   |   |   |   |   |   |   |   |   |   |                             |   |   |   |   |      |   |   |   |   |   |   |   |   |   |   |   |                             |   |   |   |   |          |   |   |   |   |   |   |   |   |   |   |   |          |   |   |   |   |                |   |   |   |   |   |   |   |   |   |   |   |                |   |   |   |   |                     |   |   |   |   |   |   |   |   |   |   |   |                   |   |   |   |   |                     |   |   |   |   |   |   |   |   |   |   |   |                  |   |   |   |   |                     |   |   |   |   |   |   |   |   |   |   |   |                  |   |   |   |   |                     |   |   |   |   |   |   |   |   |   |   |   |                               |   |   |   |   |                     |   |   |   |   |   |   |   |   |   |   |   |                               |   |   |   |   |               |   |   |   |   |   |   |   |   |   |   |   |                             |   |   |   |   |             |   |   |   |   |   |   |   |   |   |   |   |                             |   |   |   |   |               |   |   |   |   |   |   |   |   |   |   |   |          |   |   |   |   |   |   |   |   |   |   |   |   |   |   |   |   |                |   |   |   |   |   |   |   |   |   |   |   |   |   |   |   |   |
| Timer 4 (SOF Clock)   | 0        | 0    | 0    | 1   |   |                  |    |     |     | 0   | 0                | 0  | 0  | 0  | 0  | 0  | 0  | 0 | 0 | 0 | 0 |   |                   |   |   |   |   |              |   |   |   |   |   |   |   |   |   |   |   |                  |   |   |   |   |                 |   |   |   |   |   |   |   |   |   |   |   |                  |   |   |   |   |           |   |   |   |   |   |   |   |   |   |   |   |                               |   |   |   |   |                   |   |   |   |   |   |   |   |   |   |   |   |                               |   |   |   |   |                    |   |   |   |   |   |   |   |   |   |   |   |                             |   |   |   |   |      |   |   |   |   |   |   |   |   |   |   |   |                             |   |   |   |   |          |   |   |   |   |   |   |   |   |   |   |   |          |   |   |   |   |                |   |   |   |   |   |   |   |   |   |   |   |                |   |   |   |   |                     |   |   |   |   |   |   |   |   |   |   |   |                   |   |   |   |   |                     |   |   |   |   |   |   |   |   |   |   |   |                  |   |   |   |   |                     |   |   |   |   |   |   |   |   |   |   |   |                  |   |   |   |   |                     |   |   |   |   |   |   |   |   |   |   |   |                               |   |   |   |   |                     |   |   |   |   |   |   |   |   |   |   |   |                               |   |   |   |   |               |   |   |   |   |   |   |   |   |   |   |   |                             |   |   |   |   |             |   |   |   |   |   |   |   |   |   |   |   |                             |   |   |   |   |               |   |   |   |   |   |   |   |   |   |   |   |          |   |   |   |   |   |   |   |   |   |   |   |   |   |   |   |   |                |   |   |   |   |   |   |   |   |   |   |   |   |   |   |   |   |
| Reserved              | 0        | 0    | 0    | 0   |   |                  |    |     |     | 0   | 0                | 0  | 0  | 0  | 0  | 0  | 0  | 0 | 0 | 0 | 0 |   |                   |   |   |   |   |              |   |   |   |   |   |   |   |   |   |   |   |                  |   |   |   |   |                 |   |   |   |   |   |   |   |   |   |   |   |                  |   |   |   |   |           |   |   |   |   |   |   |   |   |   |   |   |                               |   |   |   |   |                   |   |   |   |   |   |   |   |   |   |   |   |                               |   |   |   |   |                    |   |   |   |   |   |   |   |   |   |   |   |                             |   |   |   |   |      |   |   |   |   |   |   |   |   |   |   |   |                             |   |   |   |   |          |   |   |   |   |   |   |   |   |   |   |   |          |   |   |   |   |                |   |   |   |   |   |   |   |   |   |   |   |                |   |   |   |   |                     |   |   |   |   |   |   |   |   |   |   |   |                   |   |   |   |   |                     |   |   |   |   |   |   |   |   |   |   |   |                  |   |   |   |   |                     |   |   |   |   |   |   |   |   |   |   |   |                  |   |   |   |   |                     |   |   |   |   |   |   |   |   |   |   |   |                               |   |   |   |   |                     |   |   |   |   |   |   |   |   |   |   |   |                               |   |   |   |   |               |   |   |   |   |   |   |   |   |   |   |   |                             |   |   |   |   |             |   |   |   |   |   |   |   |   |   |   |   |                             |   |   |   |   |               |   |   |   |   |   |   |   |   |   |   |   |          |   |   |   |   |   |   |   |   |   |   |   |   |   |   |   |   |                |   |   |   |   |   |   |   |   |   |   |   |   |   |   |   |   |
| LAN9221 IRQ           | 0        | 1    | 0    | 0   |   |                  |    |     |     | 0   | 0                | 0  | 0  | 0  | 0  | 0  | 0  | 0 | 0 | 0 | 0 |   |                   |   |   |   |   |              |   |   |   |   |   |   |   |   |   |   |   |                  |   |   |   |   |                 |   |   |   |   |   |   |   |   |   |   |   |                  |   |   |   |   |           |   |   |   |   |   |   |   |   |   |   |   |                               |   |   |   |   |                   |   |   |   |   |   |   |   |   |   |   |   |                               |   |   |   |   |                    |   |   |   |   |   |   |   |   |   |   |   |                             |   |   |   |   |      |   |   |   |   |   |   |   |   |   |   |   |                             |   |   |   |   |          |   |   |   |   |   |   |   |   |   |   |   |          |   |   |   |   |                |   |   |   |   |   |   |   |   |   |   |   |                |   |   |   |   |                     |   |   |   |   |   |   |   |   |   |   |   |                   |   |   |   |   |                     |   |   |   |   |   |   |   |   |   |   |   |                  |   |   |   |   |                     |   |   |   |   |   |   |   |   |   |   |   |                  |   |   |   |   |                     |   |   |   |   |   |   |   |   |   |   |   |                               |   |   |   |   |                     |   |   |   |   |   |   |   |   |   |   |   |                               |   |   |   |   |               |   |   |   |   |   |   |   |   |   |   |   |                             |   |   |   |   |             |   |   |   |   |   |   |   |   |   |   |   |                             |   |   |   |   |               |   |   |   |   |   |   |   |   |   |   |   |          |   |   |   |   |   |   |   |   |   |   |   |   |   |   |   |   |                |   |   |   |   |   |   |   |   |   |   |   |   |   |   |   |   |
| RTC                   | 1        | 0    | 0    | 0   |   |                  |    |     |     | 0   | 0                | 0  | 0  | 0  | 0  | 0  | 0  | 0 | 0 | 0 | 0 |   |                   |   |   |   |   |              |   |   |   |   |   |   |   |   |   |   |   |                  |   |   |   |   |                 |   |   |   |   |   |   |   |   |   |   |   |                  |   |   |   |   |           |   |   |   |   |   |   |   |   |   |   |   |                               |   |   |   |   |                   |   |   |   |   |   |   |   |   |   |   |   |                               |   |   |   |   |                    |   |   |   |   |   |   |   |   |   |   |   |                             |   |   |   |   |      |   |   |   |   |   |   |   |   |   |   |   |                             |   |   |   |   |          |   |   |   |   |   |   |   |   |   |   |   |          |   |   |   |   |                |   |   |   |   |   |   |   |   |   |   |   |                |   |   |   |   |                     |   |   |   |   |   |   |   |   |   |   |   |                   |   |   |   |   |                     |   |   |   |   |   |   |   |   |   |   |   |                  |   |   |   |   |                     |   |   |   |   |   |   |   |   |   |   |   |                  |   |   |   |   |                     |   |   |   |   |   |   |   |   |   |   |   |                               |   |   |   |   |                     |   |   |   |   |   |   |   |   |   |   |   |                               |   |   |   |   |               |   |   |   |   |   |   |   |   |   |   |   |                             |   |   |   |   |             |   |   |   |   |   |   |   |   |   |   |   |                             |   |   |   |   |               |   |   |   |   |   |   |   |   |   |   |   |          |   |   |   |   |   |   |   |   |   |   |   |   |   |   |   |   |                |   |   |   |   |   |   |   |   |   |   |   |   |   |   |   |   |
| Value @ Reset: 0x0000 |          |      |      |     |   |                  |    |     |     |   |                  |    |    |    |    |    |    |   |   |   |   |   |                   |   |   |   |   |              |   |   |   |   |   |   |   |   |   |   |   |                  |   |   |   |   |                 |   |   |   |   |   |   |   |   |   |   |   |                  |   |   |   |   |           |   |   |   |   |   |   |   |   |   |   |   |                               |   |   |   |   |                   |   |   |   |   |   |   |   |   |   |   |   |                               |   |   |   |   |                    |   |   |   |   |   |   |   |   |   |   |   |                             |   |   |   |   |      |   |   |   |   |   |   |   |   |   |   |   |                             |   |   |   |   |          |   |   |   |   |   |   |   |   |   |   |   |          |   |   |   |   |                |   |   |   |   |   |   |   |   |   |   |   |                |   |   |   |   |                     |   |   |   |   |   |   |   |   |   |   |   |                   |   |   |   |   |                     |   |   |   |   |   |   |   |   |   |   |   |                  |   |   |   |   |                     |   |   |   |   |   |   |   |   |   |   |   |                  |   |   |   |   |                     |   |   |   |   |   |   |   |   |   |   |   |                               |   |   |   |   |                     |   |   |   |   |   |   |   |   |   |   |   |                               |   |   |   |   |               |   |   |   |   |   |   |   |   |   |   |   |                             |   |   |   |   |             |   |   |   |   |   |   |   |   |   |   |   |                             |   |   |   |   |               |   |   |   |   |   |   |   |   |   |   |   |          |   |   |   |   |   |   |   |   |   |   |   |   |   |   |   |   |                |   |   |   |   |   |   |   |   |   |   |   |   |   |   |   |   |
| 0x0104                |          | 16   | I/O  | R/W |   |                  |    |     |     | <b>Interrupt Pending Register Group 2 (BEATRIX)</b>   |                  |    |    |    |    |    |    |   |   |   |   |   |                   |   |   |   |   |              |   |   |   |   |   |   |   |   |   |   |   |                  |   |   |   |   |                 |   |   |   |   |   |   |   |   |   |   |   |                  |   |   |   |   |           |   |   |   |   |   |   |   |   |   |   |   |                               |   |   |   |   |                   |   |   |   |   |   |   |   |   |   |   |   |                               |   |   |   |   |                    |   |   |   |   |   |   |   |   |   |   |   |                             |   |   |   |   |      |   |   |   |   |   |   |   |   |   |   |   |                             |   |   |   |   |          |   |   |   |   |   |   |   |   |   |   |   |          |   |   |   |   |                |   |   |   |   |   |   |   |   |   |   |   |                |   |   |   |   |                     |   |   |   |   |   |   |   |   |   |   |   |                   |   |   |   |   |                     |   |   |   |   |   |   |   |   |   |   |   |                  |   |   |   |   |                     |   |   |   |   |   |   |   |   |   |   |   |                  |   |   |   |   |                     |   |   |   |   |   |   |   |   |   |   |   |                               |   |   |   |   |                     |   |   |   |   |   |   |   |   |   |   |   |                               |   |   |   |   |               |   |   |   |   |   |   |   |   |   |   |   |                             |   |   |   |   |             |   |   |   |   |   |   |   |   |   |   |   |                             |   |   |   |   |               |   |   |   |   |   |   |   |   |   |   |   |          |   |   |   |   |   |   |   |   |   |   |   |   |   |   |   |   |                |   |   |   |   |   |   |   |   |   |   |   |   |   |   |   |   |
|                       |          |      |      |     |   |                  |    |     |     | <table border="1"> <thead> <tr> <th>Interrupt Source</th> <th>15</th><th>14</th><th>13</th><th>12</th><th>11</th><th>10</th><th>9</th><th>8</th><th>7</th><th>6</th><th>5</th><th>4</th><th>3</th><th>2</th><th>1</th><th>0</th> </tr> </thead> <tbody> <tr> <td>IDE IRQ</td> <td>0</td><td>0</td><td>0</td><td>0</td><td>0</td><td>0</td><td>0</td><td>0</td><td>0</td><td>0</td><td>0</td><td>0</td><td>0</td><td>0</td><td>0</td><td>1</td> </tr> <tr> <td>SDCard Insert</td> <td>0</td><td>0</td><td>0</td><td>0</td><td>0</td><td>0</td><td>0</td><td>0</td><td>0</td><td>0</td><td>0</td><td>0</td><td>0</td><td>0</td><td>1</td><td>0</td> </tr> <tr> <td>Reserved</td> <td>0</td><td>0</td><td>0</td><td>0</td><td>0</td><td>0</td><td>0</td><td>0</td><td>0</td><td>0</td><td>0</td><td>0</td><td>0</td><td>0</td><td>0</td><td>0</td> </tr> <tr> <td>Ext OPM Interrupt</td> <td>0</td><td>0</td><td>0</td><td>0</td><td>0</td><td>0</td><td>0</td><td>0</td><td>0</td><td>0</td><td>0</td><td>0</td><td>1</td><td>0</td><td>0</td><td>0</td> </tr> <tr> <td>Ext OPN2 Interrupt</td> <td>0</td><td>0</td><td>0</td><td>0</td><td>0</td><td>0</td><td>0</td><td>0</td><td>0</td><td>0</td><td>0</td><td>1</td><td>0</td><td>0</td><td>0</td><td>0</td> </tr> <tr> <td>OPL3</td> <td>0</td><td>0</td><td>0</td><td>0</td><td>0</td><td>0</td><td>0</td><td>0</td><td>0</td><td>0</td><td>1</td><td>0</td><td>0</td><td>0</td><td>0</td><td>0</td> </tr> <tr> <td>Reserved</td> <td>0</td><td>0</td><td>0</td><td>0</td><td>0</td><td>0</td><td>0</td><td>0</td><td>0</td><td>0</td><td>0</td><td>0</td><td>0</td><td>0</td><td>0</td><td>0</td> </tr> <tr> <td>Reserved</td> <td>0</td><td>0</td><td>0</td><td>0</td><td>0</td><td>0</td><td>0</td><td>0</td><td>0</td><td>0</td><td>0</td><td>0</td><td>0</td><td>0</td><td>0</td><td>0</td> </tr> <tr> <td>BTX INT0 (TBD)</td> <td>0</td><td>0</td><td>0</td><td>0</td><td>0</td><td>0</td><td>0</td><td>0</td><td>0</td><td>0</td><td>0</td><td>0</td><td>0</td><td>0</td><td>0</td><td>0</td> </tr> <tr> <td>BTX INT1 (TBD)</td> <td>0</td><td>0</td><td>0</td><td>0</td><td>0</td><td>0</td><td>0</td><td>0</td><td>0</td><td>0</td><td>0</td><td>0</td><td>0</td><td>0</td><td>0</td><td>0</td> </tr> <tr> <td>BTX INT2 (TBD)</td> <td>0</td><td>0</td><td>0</td><td>0</td><td>0</td><td>0</td><td>0</td><td>0</td><td>0</td><td>0</td><td>0</td><td>0</td><td>0</td><td>0</td><td>0</td><td>0</td> </tr> <tr> <td>BTX INT3 (TBD)</td> <td>0</td><td>0</td><td>0</td><td>0</td><td>0</td><td>0</td><td>0</td><td>0</td><td>0</td><td>0</td><td>0</td><td>0</td><td>0</td><td>0</td><td>0</td><td>0</td> </tr> <tr> <td>Reserved</td> <td>0</td><td>0</td><td>0</td><td>0</td><td>0</td><td>0</td><td>0</td><td>0</td><td>0</td><td>0</td><td>0</td><td>0</td><td>0</td><td>0</td><td>0</td><td>0</td> </tr> <tr> <td>DAC1 Playback</td> <td>0</td><td>0</td><td>1</td><td>0</td><td>0</td><td>0</td><td>0</td><td>0</td><td>0</td><td>0</td><td>0</td><td>0</td><td>0</td><td>0</td><td>0</td><td>0</td> </tr> <tr> <td>Reserved</td> <td>0</td><td>0</td><td>0</td><td>0</td><td>0</td><td>0</td><td>0</td><td>0</td><td>0</td><td>0</td><td>0</td><td>0</td><td>0</td><td>0</td><td>0</td><td>0</td> </tr> <tr> <td>DAC0 Playback</td> <td>1</td><td>0</td><td>0</td><td>0</td><td>0</td><td>0</td><td>0</td><td>0</td><td>0</td><td>0</td><td>0</td><td>0</td><td>0</td><td>0</td><td>0</td><td>0</td> </tr> </tbody> </table>  | Interrupt Source | 15 | 14 | 13 | 12 | 11 | 10 | 9 | 8 | 7 | 6 | 5 | 4                 | 3 | 2 | 1 | 0 | IDE IRQ      | 0 | 0 | 0 | 0 | 0 | 0 | 0 | 0 | 0 | 0 | 0 | 0                | 0 | 0 | 0 | 1 | SDCard Insert   | 0 | 0 | 0 | 0 | 0 | 0 | 0 | 0 | 0 | 0 | 0 | 0                | 0 | 0 | 1 | 0 | Reserved  | 0 | 0 | 0 | 0 | 0 | 0 | 0 | 0 | 0 | 0 | 0 | 0                             | 0 | 0 | 0 | 0 | Ext OPM Interrupt | 0 | 0 | 0 | 0 | 0 | 0 | 0 | 0 | 0 | 0 | 0 | 0                             | 1 | 0 | 0 | 0 | Ext OPN2 Interrupt | 0 | 0 | 0 | 0 | 0 | 0 | 0 | 0 | 0 | 0 | 0 | 1                           | 0 | 0 | 0 | 0 | OPL3 | 0 | 0 | 0 | 0 | 0 | 0 | 0 | 0 | 0 | 0 | 1 | 0                           | 0 | 0 | 0 | 0 | Reserved | 0 | 0 | 0 | 0 | 0 | 0 | 0 | 0 | 0 | 0 | 0 | 0        | 0 | 0 | 0 | 0 | Reserved       | 0 | 0 | 0 | 0 | 0 | 0 | 0 | 0 | 0 | 0 | 0 | 0              | 0 | 0 | 0 | 0 | BTX INT0 (TBD)      | 0 | 0 | 0 | 0 | 0 | 0 | 0 | 0 | 0 | 0 | 0 | 0                 | 0 | 0 | 0 | 0 | BTX INT1 (TBD)      | 0 | 0 | 0 | 0 | 0 | 0 | 0 | 0 | 0 | 0 | 0 | 0                | 0 | 0 | 0 | 0 | BTX INT2 (TBD)      | 0 | 0 | 0 | 0 | 0 | 0 | 0 | 0 | 0 | 0 | 0 | 0                | 0 | 0 | 0 | 0 | BTX INT3 (TBD)      | 0 | 0 | 0 | 0 | 0 | 0 | 0 | 0 | 0 | 0 | 0 | 0                             | 0 | 0 | 0 | 0 | Reserved            | 0 | 0 | 0 | 0 | 0 | 0 | 0 | 0 | 0 | 0 | 0 | 0                             | 0 | 0 | 0 | 0 | DAC1 Playback | 0 | 0 | 1 | 0 | 0 | 0 | 0 | 0 | 0 | 0 | 0 | 0                           | 0 | 0 | 0 | 0 | Reserved    | 0 | 0 | 0 | 0 | 0 | 0 | 0 | 0 | 0 | 0 | 0 | 0                           | 0 | 0 | 0 | 0 | DAC0 Playback | 1 | 0 | 0 | 0 | 0 | 0 | 0 | 0 | 0 | 0 | 0 | 0        | 0 | 0 | 0 | 0 |   |   |   |   |   |   |   |   |   |   |   |   |                |   |   |   |   |   |   |   |   |   |   |   |   |   |   |   |   |
|                       |          |      |      |     |   |                  |    |     |     | Interrupt Source  | 15               | 14 | 13 | 12 | 11 | 10 | 9  | 8 | 7 | 6 | 5 | 4 | 3                 | 2 | 1 | 0 |   |              |   |   |   |   |   |   |   |   |   |   |   |                  |   |   |   |   |                 |   |   |   |   |   |   |   |   |   |   |   |                  |   |   |   |   |           |   |   |   |   |   |   |   |   |   |   |   |                               |   |   |   |   |                   |   |   |   |   |   |   |   |   |   |   |   |                               |   |   |   |   |                    |   |   |   |   |   |   |   |   |   |   |   |                             |   |   |   |   |      |   |   |   |   |   |   |   |   |   |   |   |                             |   |   |   |   |          |   |   |   |   |   |   |   |   |   |   |   |          |   |   |   |   |                |   |   |   |   |   |   |   |   |   |   |   |                |   |   |   |   |                     |   |   |   |   |   |   |   |   |   |   |   |                   |   |   |   |   |                     |   |   |   |   |   |   |   |   |   |   |   |                  |   |   |   |   |                     |   |   |   |   |   |   |   |   |   |   |   |                  |   |   |   |   |                     |   |   |   |   |   |   |   |   |   |   |   |                               |   |   |   |   |                     |   |   |   |   |   |   |   |   |   |   |   |                               |   |   |   |   |               |   |   |   |   |   |   |   |   |   |   |   |                             |   |   |   |   |             |   |   |   |   |   |   |   |   |   |   |   |                             |   |   |   |   |               |   |   |   |   |   |   |   |   |   |   |   |          |   |   |   |   |   |   |   |   |   |   |   |   |   |   |   |   |                |   |   |   |   |   |   |   |   |   |   |   |   |   |   |   |   |
|                       |          |      |      |     |   |                  |    |     |     | IDE IRQ   | 0                | 0  | 0  | 0  | 0  | 0  | 0  | 0 | 0 | 0 | 0 | 0 | 0                 | 0 | 0 | 1 |   |              |   |   |   |   |   |   |   |   |   |   |   |                  |   |   |   |   |                 |   |   |   |   |   |   |   |   |   |   |   |                  |   |   |   |   |           |   |   |   |   |   |   |   |   |   |   |   |                               |   |   |   |   |                   |   |   |   |   |   |   |   |   |   |   |   |                               |   |   |   |   |                    |   |   |   |   |   |   |   |   |   |   |   |                             |   |   |   |   |      |   |   |   |   |   |   |   |   |   |   |   |                             |   |   |   |   |          |   |   |   |   |   |   |   |   |   |   |   |          |   |   |   |   |                |   |   |   |   |   |   |   |   |   |   |   |                |   |   |   |   |                     |   |   |   |   |   |   |   |   |   |   |   |                   |   |   |   |   |                     |   |   |   |   |   |   |   |   |   |   |   |                  |   |   |   |   |                     |   |   |   |   |   |   |   |   |   |   |   |                  |   |   |   |   |                     |   |   |   |   |   |   |   |   |   |   |   |                               |   |   |   |   |                     |   |   |   |   |   |   |   |   |   |   |   |                               |   |   |   |   |               |   |   |   |   |   |   |   |   |   |   |   |                             |   |   |   |   |             |   |   |   |   |   |   |   |   |   |   |   |                             |   |   |   |   |               |   |   |   |   |   |   |   |   |   |   |   |          |   |   |   |   |   |   |   |   |   |   |   |   |   |   |   |   |                |   |   |   |   |   |   |   |   |   |   |   |   |   |   |   |   |
|                       |          |      |      |     |   |                  |    |     |     | SDCard Insert   | 0                | 0  | 0  | 0  | 0  | 0  | 0  | 0 | 0 | 0 | 0 | 0 | 0                 | 0 | 1 | 0 |   |              |   |   |   |   |   |   |   |   |   |   |   |                  |   |   |   |   |                 |   |   |   |   |   |   |   |   |   |   |   |                  |   |   |   |   |           |   |   |   |   |   |   |   |   |   |   |   |                               |   |   |   |   |                   |   |   |   |   |   |   |   |   |   |   |   |                               |   |   |   |   |                    |   |   |   |   |   |   |   |   |   |   |   |                             |   |   |   |   |      |   |   |   |   |   |   |   |   |   |   |   |                             |   |   |   |   |          |   |   |   |   |   |   |   |   |   |   |   |          |   |   |   |   |                |   |   |   |   |   |   |   |   |   |   |   |                |   |   |   |   |                     |   |   |   |   |   |   |   |   |   |   |   |                   |   |   |   |   |                     |   |   |   |   |   |   |   |   |   |   |   |                  |   |   |   |   |                     |   |   |   |   |   |   |   |   |   |   |   |                  |   |   |   |   |                     |   |   |   |   |   |   |   |   |   |   |   |                               |   |   |   |   |                     |   |   |   |   |   |   |   |   |   |   |   |                               |   |   |   |   |               |   |   |   |   |   |   |   |   |   |   |   |                             |   |   |   |   |             |   |   |   |   |   |   |   |   |   |   |   |                             |   |   |   |   |               |   |   |   |   |   |   |   |   |   |   |   |          |   |   |   |   |   |   |   |   |   |   |   |   |   |   |   |   |                |   |   |   |   |   |   |   |   |   |   |   |   |   |   |   |   |
|                       |          |      |      |     |   |                  |    |     |     | Reserved  | 0                | 0  | 0  | 0  | 0  | 0  | 0  | 0 | 0 | 0 | 0 | 0 | 0                 | 0 | 0 | 0 |   |              |   |   |   |   |   |   |   |   |   |   |   |                  |   |   |   |   |                 |   |   |   |   |   |   |   |   |   |   |   |                  |   |   |   |   |           |   |   |   |   |   |   |   |   |   |   |   |                               |   |   |   |   |                   |   |   |   |   |   |   |   |   |   |   |   |                               |   |   |   |   |                    |   |   |   |   |   |   |   |   |   |   |   |                             |   |   |   |   |      |   |   |   |   |   |   |   |   |   |   |   |                             |   |   |   |   |          |   |   |   |   |   |   |   |   |   |   |   |          |   |   |   |   |                |   |   |   |   |   |   |   |   |   |   |   |                |   |   |   |   |                     |   |   |   |   |   |   |   |   |   |   |   |                   |   |   |   |   |                     |   |   |   |   |   |   |   |   |   |   |   |                  |   |   |   |   |                     |   |   |   |   |   |   |   |   |   |   |   |                  |   |   |   |   |                     |   |   |   |   |   |   |   |   |   |   |   |                               |   |   |   |   |                     |   |   |   |   |   |   |   |   |   |   |   |                               |   |   |   |   |               |   |   |   |   |   |   |   |   |   |   |   |                             |   |   |   |   |             |   |   |   |   |   |   |   |   |   |   |   |                             |   |   |   |   |               |   |   |   |   |   |   |   |   |   |   |   |          |   |   |   |   |   |   |   |   |   |   |   |   |   |   |   |   |                |   |   |   |   |   |   |   |   |   |   |   |   |   |   |   |   |
|                       |          |      |      |     |   |                  |    |     |     | Ext OPM Interrupt   | 0                | 0  | 0  | 0  | 0  | 0  | 0  | 0 | 0 | 0 | 0 | 0 | 1                 | 0 | 0 | 0 |   |              |   |   |   |   |   |   |   |   |   |   |   |                  |   |   |   |   |                 |   |   |   |   |   |   |   |   |   |   |   |                  |   |   |   |   |           |   |   |   |   |   |   |   |   |   |   |   |                               |   |   |   |   |                   |   |   |   |   |   |   |   |   |   |   |   |                               |   |   |   |   |                    |   |   |   |   |   |   |   |   |   |   |   |                             |   |   |   |   |      |   |   |   |   |   |   |   |   |   |   |   |                             |   |   |   |   |          |   |   |   |   |   |   |   |   |   |   |   |          |   |   |   |   |                |   |   |   |   |   |   |   |   |   |   |   |                |   |   |   |   |                     |   |   |   |   |   |   |   |   |   |   |   |                   |   |   |   |   |                     |   |   |   |   |   |   |   |   |   |   |   |                  |   |   |   |   |                     |   |   |   |   |   |   |   |   |   |   |   |                  |   |   |   |   |                     |   |   |   |   |   |   |   |   |   |   |   |                               |   |   |   |   |                     |   |   |   |   |   |   |   |   |   |   |   |                               |   |   |   |   |               |   |   |   |   |   |   |   |   |   |   |   |                             |   |   |   |   |             |   |   |   |   |   |   |   |   |   |   |   |                             |   |   |   |   |               |   |   |   |   |   |   |   |   |   |   |   |          |   |   |   |   |   |   |   |   |   |   |   |   |   |   |   |   |                |   |   |   |   |   |   |   |   |   |   |   |   |   |   |   |   |
|                       |          |      |      |     | Ext OPN2 Interrupt  | 0                | 0  | 0   | 0   | 0   | 0                | 0  | 0  | 0  | 0  | 0  | 1  | 0 | 0 | 0 | 0 |   |                   |   |   |   |   |              |   |   |   |   |   |   |   |   |   |   |   |                  |   |   |   |   |                 |   |   |   |   |   |   |   |   |   |   |   |                  |   |   |   |   |           |   |   |   |   |   |   |   |   |   |   |   |                               |   |   |   |   |                   |   |   |   |   |   |   |   |   |   |   |   |                               |   |   |   |   |                    |   |   |   |   |   |   |   |   |   |   |   |                             |   |   |   |   |      |   |   |   |   |   |   |   |   |   |   |   |                             |   |   |   |   |          |   |   |   |   |   |   |   |   |   |   |   |          |   |   |   |   |                |   |   |   |   |   |   |   |   |   |   |   |                |   |   |   |   |                     |   |   |   |   |   |   |   |   |   |   |   |                   |   |   |   |   |                     |   |   |   |   |   |   |   |   |   |   |   |                  |   |   |   |   |                     |   |   |   |   |   |   |   |   |   |   |   |                  |   |   |   |   |                     |   |   |   |   |   |   |   |   |   |   |   |                               |   |   |   |   |                     |   |   |   |   |   |   |   |   |   |   |   |                               |   |   |   |   |               |   |   |   |   |   |   |   |   |   |   |   |                             |   |   |   |   |             |   |   |   |   |   |   |   |   |   |   |   |                             |   |   |   |   |               |   |   |   |   |   |   |   |   |   |   |   |          |   |   |   |   |   |   |   |   |   |   |   |   |   |   |   |   |                |   |   |   |   |   |   |   |   |   |   |   |   |   |   |   |   |
|                       |          |      |      |     | OPL3  | 0                | 0  | 0   | 0   | 0   | 0                | 0  | 0  | 0  | 0  | 1  | 0  | 0 | 0 | 0 | 0 |   |                   |   |   |   |   |              |   |   |   |   |   |   |   |   |   |   |   |                  |   |   |   |   |                 |   |   |   |   |   |   |   |   |   |   |   |                  |   |   |   |   |           |   |   |   |   |   |   |   |   |   |   |   |                               |   |   |   |   |                   |   |   |   |   |   |   |   |   |   |   |   |                               |   |   |   |   |                    |   |   |   |   |   |   |   |   |   |   |   |                             |   |   |   |   |      |   |   |   |   |   |   |   |   |   |   |   |                             |   |   |   |   |          |   |   |   |   |   |   |   |   |   |   |   |          |   |   |   |   |                |   |   |   |   |   |   |   |   |   |   |   |                |   |   |   |   |                     |   |   |   |   |   |   |   |   |   |   |   |                   |   |   |   |   |                     |   |   |   |   |   |   |   |   |   |   |   |                  |   |   |   |   |                     |   |   |   |   |   |   |   |   |   |   |   |                  |   |   |   |   |                     |   |   |   |   |   |   |   |   |   |   |   |                               |   |   |   |   |                     |   |   |   |   |   |   |   |   |   |   |   |                               |   |   |   |   |               |   |   |   |   |   |   |   |   |   |   |   |                             |   |   |   |   |             |   |   |   |   |   |   |   |   |   |   |   |                             |   |   |   |   |               |   |   |   |   |   |   |   |   |   |   |   |          |   |   |   |   |   |   |   |   |   |   |   |   |   |   |   |   |                |   |   |   |   |   |   |   |   |   |   |   |   |   |   |   |   |
|                       |          |      |      |     | Reserved  | 0                | 0  | 0   | 0   | 0   | 0                | 0  | 0  | 0  | 0  | 0  | 0  | 0 | 0 | 0 | 0 |   |                   |   |   |   |   |              |   |   |   |   |   |   |   |   |   |   |   |                  |   |   |   |   |                 |   |   |   |   |   |   |   |   |   |   |   |                  |   |   |   |   |           |   |   |   |   |   |   |   |   |   |   |   |                               |   |   |   |   |                   |   |   |   |   |   |   |   |   |   |   |   |                               |   |   |   |   |                    |   |   |   |   |   |   |   |   |   |   |   |                             |   |   |   |   |      |   |   |   |   |   |   |   |   |   |   |   |                             |   |   |   |   |          |   |   |   |   |   |   |   |   |   |   |   |          |   |   |   |   |                |   |   |   |   |   |   |   |   |   |   |   |                |   |   |   |   |                     |   |   |   |   |   |   |   |   |   |   |   |                   |   |   |   |   |                     |   |   |   |   |   |   |   |   |   |   |   |                  |   |   |   |   |                     |   |   |   |   |   |   |   |   |   |   |   |                  |   |   |   |   |                     |   |   |   |   |   |   |   |   |   |   |   |                               |   |   |   |   |                     |   |   |   |   |   |   |   |   |   |   |   |                               |   |   |   |   |               |   |   |   |   |   |   |   |   |   |   |   |                             |   |   |   |   |             |   |   |   |   |   |   |   |   |   |   |   |                             |   |   |   |   |               |   |   |   |   |   |   |   |   |   |   |   |          |   |   |   |   |   |   |   |   |   |   |   |   |   |   |   |   |                |   |   |   |   |   |   |   |   |   |   |   |   |   |   |   |   |
|                       |          |      |      |     | Reserved  | 0                | 0  | 0   | 0   | 0   | 0                | 0  | 0  | 0  | 0  | 0  | 0  | 0 | 0 | 0 | 0 |   |                   |   |   |   |   |              |   |   |   |   |   |   |   |   |   |   |   |                  |   |   |   |   |                 |   |   |   |   |   |   |   |   |   |   |   |                  |   |   |   |   |           |   |   |   |   |   |   |   |   |   |   |   |                               |   |   |   |   |                   |   |   |   |   |   |   |   |   |   |   |   |                               |   |   |   |   |                    |   |   |   |   |   |   |   |   |   |   |   |                             |   |   |   |   |      |   |   |   |   |   |   |   |   |   |   |   |                             |   |   |   |   |          |   |   |   |   |   |   |   |   |   |   |   |          |   |   |   |   |                |   |   |   |   |   |   |   |   |   |   |   |                |   |   |   |   |                     |   |   |   |   |   |   |   |   |   |   |   |                   |   |   |   |   |                     |   |   |   |   |   |   |   |   |   |   |   |                  |   |   |   |   |                     |   |   |   |   |   |   |   |   |   |   |   |                  |   |   |   |   |                     |   |   |   |   |   |   |   |   |   |   |   |                               |   |   |   |   |                     |   |   |   |   |   |   |   |   |   |   |   |                               |   |   |   |   |               |   |   |   |   |   |   |   |   |   |   |   |                             |   |   |   |   |             |   |   |   |   |   |   |   |   |   |   |   |                             |   |   |   |   |               |   |   |   |   |   |   |   |   |   |   |   |          |   |   |   |   |   |   |   |   |   |   |   |   |   |   |   |   |                |   |   |   |   |   |   |   |   |   |   |   |   |   |   |   |   |
|                       |          |      |      |     | BTX INT0 (TBD)  | 0                | 0  | 0   | 0   | 0   | 0                | 0  | 0  | 0  | 0  | 0  | 0  | 0 | 0 | 0 | 0 |   |                   |   |   |   |   |              |   |   |   |   |   |   |   |   |   |   |   |                  |   |   |   |   |                 |   |   |   |   |   |   |   |   |   |   |   |                  |   |   |   |   |           |   |   |   |   |   |   |   |   |   |   |   |                               |   |   |   |   |                   |   |   |   |   |   |   |   |   |   |   |   |                               |   |   |   |   |                    |   |   |   |   |   |   |   |   |   |   |   |                             |   |   |   |   |      |   |   |   |   |   |   |   |   |   |   |   |                             |   |   |   |   |          |   |   |   |   |   |   |   |   |   |   |   |          |   |   |   |   |                |   |   |   |   |   |   |   |   |   |   |   |                |   |   |   |   |                     |   |   |   |   |   |   |   |   |   |   |   |                   |   |   |   |   |                     |   |   |   |   |   |   |   |   |   |   |   |                  |   |   |   |   |                     |   |   |   |   |   |   |   |   |   |   |   |                  |   |   |   |   |                     |   |   |   |   |   |   |   |   |   |   |   |                               |   |   |   |   |                     |   |   |   |   |   |   |   |   |   |   |   |                               |   |   |   |   |               |   |   |   |   |   |   |   |   |   |   |   |                             |   |   |   |   |             |   |   |   |   |   |   |   |   |   |   |   |                             |   |   |   |   |               |   |   |   |   |   |   |   |   |   |   |   |          |   |   |   |   |   |   |   |   |   |   |   |   |   |   |   |   |                |   |   |   |   |   |   |   |   |   |   |   |   |   |   |   |   |
|                       |          |      |      |     | BTX INT1 (TBD)  | 0                | 0  | 0   | 0   | 0   | 0                | 0  | 0  | 0  | 0  | 0  | 0  | 0 | 0 | 0 | 0 |   |                   |   |   |   |   |              |   |   |   |   |   |   |   |   |   |   |   |                  |   |   |   |   |                 |   |   |   |   |   |   |   |   |   |   |   |                  |   |   |   |   |           |   |   |   |   |   |   |   |   |   |   |   |                               |   |   |   |   |                   |   |   |   |   |   |   |   |   |   |   |   |                               |   |   |   |   |                    |   |   |   |   |   |   |   |   |   |   |   |                             |   |   |   |   |      |   |   |   |   |   |   |   |   |   |   |   |                             |   |   |   |   |          |   |   |   |   |   |   |   |   |   |   |   |          |   |   |   |   |                |   |   |   |   |   |   |   |   |   |   |   |                |   |   |   |   |                     |   |   |   |   |   |   |   |   |   |   |   |                   |   |   |   |   |                     |   |   |   |   |   |   |   |   |   |   |   |                  |   |   |   |   |                     |   |   |   |   |   |   |   |   |   |   |   |                  |   |   |   |   |                     |   |   |   |   |   |   |   |   |   |   |   |                               |   |   |   |   |                     |   |   |   |   |   |   |   |   |   |   |   |                               |   |   |   |   |               |   |   |   |   |   |   |   |   |   |   |   |                             |   |   |   |   |             |   |   |   |   |   |   |   |   |   |   |   |                             |   |   |   |   |               |   |   |   |   |   |   |   |   |   |   |   |          |   |   |   |   |   |   |   |   |   |   |   |   |   |   |   |   |                |   |   |   |   |   |   |   |   |   |   |   |   |   |   |   |   |
|                       |          |      |      |     | BTX INT2 (TBD)  | 0                | 0  | 0   | 0   | 0   | 0                | 0  | 0  | 0  | 0  | 0  | 0  | 0 | 0 | 0 | 0 |   |                   |   |   |   |   |              |   |   |   |   |   |   |   |   |   |   |   |                  |   |   |   |   |                 |   |   |   |   |   |   |   |   |   |   |   |                  |   |   |   |   |           |   |   |   |   |   |   |   |   |   |   |   |                               |   |   |   |   |                   |   |   |   |   |   |   |   |   |   |   |   |                               |   |   |   |   |                    |   |   |   |   |   |   |   |   |   |   |   |                             |   |   |   |   |      |   |   |   |   |   |   |   |   |   |   |   |                             |   |   |   |   |          |   |   |   |   |   |   |   |   |   |   |   |          |   |   |   |   |                |   |   |   |   |   |   |   |   |   |   |   |                |   |   |   |   |                     |   |   |   |   |   |   |   |   |   |   |   |                   |   |   |   |   |                     |   |   |   |   |   |   |   |   |   |   |   |                  |   |   |   |   |                     |   |   |   |   |   |   |   |   |   |   |   |                  |   |   |   |   |                     |   |   |   |   |   |   |   |   |   |   |   |                               |   |   |   |   |                     |   |   |   |   |   |   |   |   |   |   |   |                               |   |   |   |   |               |   |   |   |   |   |   |   |   |   |   |   |                             |   |   |   |   |             |   |   |   |   |   |   |   |   |   |   |   |                             |   |   |   |   |               |   |   |   |   |   |   |   |   |   |   |   |          |   |   |   |   |   |   |   |   |   |   |   |   |   |   |   |   |                |   |   |   |   |   |   |   |   |   |   |   |   |   |   |   |   |
|                       |          |      |      |     | BTX INT3 (TBD)  | 0                | 0  | 0   | 0   | 0   | 0                | 0  | 0  | 0  | 0  | 0  | 0  | 0 | 0 | 0 | 0 |   |                   |   |   |   |   |              |   |   |   |   |   |   |   |   |   |   |   |                  |   |   |   |   |                 |   |   |   |   |   |   |   |   |   |   |   |                  |   |   |   |   |           |   |   |   |   |   |   |   |   |   |   |   |                               |   |   |   |   |                   |   |   |   |   |   |   |   |   |   |   |   |                               |   |   |   |   |                    |   |   |   |   |   |   |   |   |   |   |   |                             |   |   |   |   |      |   |   |   |   |   |   |   |   |   |   |   |                             |   |   |   |   |          |   |   |   |   |   |   |   |   |   |   |   |          |   |   |   |   |                |   |   |   |   |   |   |   |   |   |   |   |                |   |   |   |   |                     |   |   |   |   |   |   |   |   |   |   |   |                   |   |   |   |   |                     |   |   |   |   |   |   |   |   |   |   |   |                  |   |   |   |   |                     |   |   |   |   |   |   |   |   |   |   |   |                  |   |   |   |   |                     |   |   |   |   |   |   |   |   |   |   |   |                               |   |   |   |   |                     |   |   |   |   |   |   |   |   |   |   |   |                               |   |   |   |   |               |   |   |   |   |   |   |   |   |   |   |   |                             |   |   |   |   |             |   |   |   |   |   |   |   |   |   |   |   |                             |   |   |   |   |               |   |   |   |   |   |   |   |   |   |   |   |          |   |   |   |   |   |   |   |   |   |   |   |   |   |   |   |   |                |   |   |   |   |   |   |   |   |   |   |   |   |   |   |   |   |
|                       |          |      |      |     | Reserved  | 0                | 0  | 0   | 0   | 0   | 0                | 0  | 0  | 0  | 0  | 0  | 0  | 0 | 0 | 0 | 0 |   |                   |   |   |   |   |              |   |   |   |   |   |   |   |   |   |   |   |                  |   |   |   |   |                 |   |   |   |   |   |   |   |   |   |   |   |                  |   |   |   |   |           |   |   |   |   |   |   |   |   |   |   |   |                               |   |   |   |   |                   |   |   |   |   |   |   |   |   |   |   |   |                               |   |   |   |   |                    |   |   |   |   |   |   |   |   |   |   |   |                             |   |   |   |   |      |   |   |   |   |   |   |   |   |   |   |   |                             |   |   |   |   |          |   |   |   |   |   |   |   |   |   |   |   |          |   |   |   |   |                |   |   |   |   |   |   |   |   |   |   |   |                |   |   |   |   |                     |   |   |   |   |   |   |   |   |   |   |   |                   |   |   |   |   |                     |   |   |   |   |   |   |   |   |   |   |   |                  |   |   |   |   |                     |   |   |   |   |   |   |   |   |   |   |   |                  |   |   |   |   |                     |   |   |   |   |   |   |   |   |   |   |   |                               |   |   |   |   |                     |   |   |   |   |   |   |   |   |   |   |   |                               |   |   |   |   |               |   |   |   |   |   |   |   |   |   |   |   |                             |   |   |   |   |             |   |   |   |   |   |   |   |   |   |   |   |                             |   |   |   |   |               |   |   |   |   |   |   |   |   |   |   |   |          |   |   |   |   |   |   |   |   |   |   |   |   |   |   |   |   |                |   |   |   |   |   |   |   |   |   |   |   |   |   |   |   |   |
|                       |          |      |      |     | DAC1 Playback   | 0                | 0  | 1   | 0   | 0   | 0                | 0  | 0  | 0  | 0  | 0  | 0  | 0 | 0 | 0 | 0 |   |                   |   |   |   |   |              |   |   |   |   |   |   |   |   |   |   |   |                  |   |   |   |   |                 |   |   |   |   |   |   |   |   |   |   |   |                  |   |   |   |   |           |   |   |   |   |   |   |   |   |   |   |   |                               |   |   |   |   |                   |   |   |   |   |   |   |   |   |   |   |   |                               |   |   |   |   |                    |   |   |   |   |   |   |   |   |   |   |   |                             |   |   |   |   |      |   |   |   |   |   |   |   |   |   |   |   |                             |   |   |   |   |          |   |   |   |   |   |   |   |   |   |   |   |          |   |   |   |   |                |   |   |   |   |   |   |   |   |   |   |   |                |   |   |   |   |                     |   |   |   |   |   |   |   |   |   |   |   |                   |   |   |   |   |                     |   |   |   |   |   |   |   |   |   |   |   |                  |   |   |   |   |                     |   |   |   |   |   |   |   |   |   |   |   |                  |   |   |   |   |                     |   |   |   |   |   |   |   |   |   |   |   |                               |   |   |   |   |                     |   |   |   |   |   |   |   |   |   |   |   |                               |   |   |   |   |               |   |   |   |   |   |   |   |   |   |   |   |                             |   |   |   |   |             |   |   |   |   |   |   |   |   |   |   |   |                             |   |   |   |   |               |   |   |   |   |   |   |   |   |   |   |   |          |   |   |   |   |   |   |   |   |   |   |   |   |   |   |   |   |                |   |   |   |   |   |   |   |   |   |   |   |   |   |   |   |   |
|                       |          |      |      |     | Reserved  | 0                | 0  | 0   | 0   | 0   | 0                | 0  | 0  | 0  | 0  | 0  | 0  | 0 | 0 | 0 | 0 |   |                   |   |   |   |   |              |   |   |   |   |   |   |   |   |   |   |   |                  |   |   |   |   |                 |   |   |   |   |   |   |   |   |   |   |   |                  |   |   |   |   |           |   |   |   |   |   |   |   |   |   |   |   |                               |   |   |   |   |                   |   |   |   |   |   |   |   |   |   |   |   |                               |   |   |   |   |                    |   |   |   |   |   |   |   |   |   |   |   |                             |   |   |   |   |      |   |   |   |   |   |   |   |   |   |   |   |                             |   |   |   |   |          |   |   |   |   |   |   |   |   |   |   |   |          |   |   |   |   |                |   |   |   |   |   |   |   |   |   |   |   |                |   |   |   |   |                     |   |   |   |   |   |   |   |   |   |   |   |                   |   |   |   |   |                     |   |   |   |   |   |   |   |   |   |   |   |                  |   |   |   |   |                     |   |   |   |   |   |   |   |   |   |   |   |                  |   |   |   |   |                     |   |   |   |   |   |   |   |   |   |   |   |                               |   |   |   |   |                     |   |   |   |   |   |   |   |   |   |   |   |                               |   |   |   |   |               |   |   |   |   |   |   |   |   |   |   |   |                             |   |   |   |   |             |   |   |   |   |   |   |   |   |   |   |   |                             |   |   |   |   |               |   |   |   |   |   |   |   |   |   |   |   |          |   |   |   |   |   |   |   |   |   |   |   |   |   |   |   |   |                |   |   |   |   |   |   |   |   |   |   |   |   |   |   |   |   |
|                       |          |      |      |     | DAC0 Playback   | 1                | 0  | 0   | 0   | 0   | 0                | 0  | 0  | 0  | 0  | 0  | 0  | 0 | 0 | 0 | 0 |   |                   |   |   |   |   |              |   |   |   |   |   |   |   |   |   |   |   |                  |   |   |   |   |                 |   |   |   |   |   |   |   |   |   |   |   |                  |   |   |   |   |           |   |   |   |   |   |   |   |   |   |   |   |                               |   |   |   |   |                   |   |   |   |   |   |   |   |   |   |   |   |                               |   |   |   |   |                    |   |   |   |   |   |   |   |   |   |   |   |                             |   |   |   |   |      |   |   |   |   |   |   |   |   |   |   |   |                             |   |   |   |   |          |   |   |   |   |   |   |   |   |   |   |   |          |   |   |   |   |                |   |   |   |   |   |   |   |   |   |   |   |                |   |   |   |   |                     |   |   |   |   |   |   |   |   |   |   |   |                   |   |   |   |   |                     |   |   |   |   |   |   |   |   |   |   |   |                  |   |   |   |   |                     |   |   |   |   |   |   |   |   |   |   |   |                  |   |   |   |   |                     |   |   |   |   |   |   |   |   |   |   |   |                               |   |   |   |   |                     |   |   |   |   |   |   |   |   |   |   |   |                               |   |   |   |   |               |   |   |   |   |   |   |   |   |   |   |   |                             |   |   |   |   |             |   |   |   |   |   |   |   |   |   |   |   |                             |   |   |   |   |               |   |   |   |   |   |   |   |   |   |   |   |          |   |   |   |   |   |   |   |   |   |   |   |   |   |   |   |   |                |   |   |   |   |   |   |   |   |   |   |   |   |   |   |   |   |
|                       |          |      |      |     | Value @ Reset: 0x0000   |                  |    |     |     |   |                  |    |    |    |    |    |    |   |   |   |   |   |                   |   |   |   |   |              |   |   |   |   |   |   |   |   |   |   |   |                  |   |   |   |   |                 |   |   |   |   |   |   |   |   |   |   |   |                  |   |   |   |   |           |   |   |   |   |   |   |   |   |   |   |   |                               |   |   |   |   |                   |   |   |   |   |   |   |   |   |   |   |   |                               |   |   |   |   |                    |   |   |   |   |   |   |   |   |   |   |   |                             |   |   |   |   |      |   |   |   |   |   |   |   |   |   |   |   |                             |   |   |   |   |          |   |   |   |   |   |   |   |   |   |   |   |          |   |   |   |   |                |   |   |   |   |   |   |   |   |   |   |   |                |   |   |   |   |                     |   |   |   |   |   |   |   |   |   |   |   |                   |   |   |   |   |                     |   |   |   |   |   |   |   |   |   |   |   |                  |   |   |   |   |                     |   |   |   |   |   |   |   |   |   |   |   |                  |   |   |   |   |                     |   |   |   |   |   |   |   |   |   |   |   |                               |   |   |   |   |                     |   |   |   |   |   |   |   |   |   |   |   |                               |   |   |   |   |               |   |   |   |   |   |   |   |   |   |   |   |                             |   |   |   |   |             |   |   |   |   |   |   |   |   |   |   |   |                             |   |   |   |   |               |   |   |   |   |   |   |   |   |   |   |   |          |   |   |   |   |   |   |   |   |   |   |   |   |   |   |   |   |                |   |   |   |   |   |   |   |   |   |   |   |   |   |   |   |   |

# A2560 FOENIX K - User Manual

|               |  |           |            |            |   |
|---------------|--|-----------|------------|------------|---|
| <b>0x0106</b> |  | <b>16</b> | <b>I/O</b> | <b>R/W</b> | <b>Reserved</b>   |
| <b>0x0108</b> |  | <b>16</b> | <b>I/O</b> | <b>R/W</b> | <b>Polarity Register Group 0 (Not in Use)</b> Value @ Reset: 0x0000 |
| <b>0x010A</b> |  | <b>16</b> | <b>I/O</b> | <b>R/W</b> | <b>Polarity Register Group 1 (Not in Use)</b> Value @ Reset: 0x0000 |
| <b>0x010C</b> |  | <b>16</b> | <b>I/O</b> | <b>R/W</b> | <b>Polarity Register Group 2 (Not in Use)</b> Value @ Reset: 0x0000 |
| <b>0x010E</b> |  | <b>16</b> | <b>I/O</b> | <b>R/W</b> | <b>Reserved</b>   |
| <b>0x0110</b> |  | <b>16</b> | <b>I/O</b> | <b>R/W</b> | <b>EDGE Register Group 0 (Not in Use)</b> Value @ Reset: 0xFFFF     |
| <b>0x0112</b> |  | <b>16</b> | <b>I/O</b> | <b>R/W</b> | <b>EDGE Register Group 1 (Not in Use)</b> Value @ Reset: 0xFFFF     |
| <b>0x0114</b> |  | <b>16</b> | <b>I/O</b> | <b>R/W</b> | <b>EDGE Register Group 2 (Not in Use)</b> Value @ Reset: 0xFFFF     |
| <b>0x0116</b> |  | <b>16</b> | <b>I/O</b> | <b>R/W</b> | <b>Reserved</b>   |
| <b>0x0118</b> |  | <b>16</b> | <b>I/O</b> | <b>R/W</b> | <b>MASK Register Group 0</b> Value @ Reset: 0xFFFF                  |
| <b>0x011A</b> |  | <b>16</b> | <b>I/O</b> | <b>R/W</b> | <b>MASK Register Group 1</b> Value @ Reset: 0xFFFF                  |
| <b>0x011C</b> |  | <b>16</b> | <b>I/O</b> | <b>R/W</b> | <b>MASK Register Group 2</b> Value @ Reset: 0xFFFF                  |
| <b>0x011E</b> |  | <b>16</b> | <b>I/O</b> | <b>R/W</b> | <b>Reserved</b>   |

## Priority Level & Grouping

| <b>IPL</b> | <b>Priority</b>  | <b>Group Definition</b>                                | <b>VECTORS</b>            |
|------------|------------------|--|---------------------------|
| <b>111</b> | No Interrupt     |  |                           |
| <b>110</b> | Lowest Priority  | BEATRIX – DAC  | 0x58..0x5F – INT Group 2B |
| <b>101</b> |                  | BEATRIX – IDE/SD, Yamaha                               | 0x50..0x57 – INT Group 2A |
| <b>100</b> |                  | GAVIN - Timer Group                                    | 0x48..0x4F – INT Group 1B |
| <b>011</b> |                  | GAVIN - SuperIO Group (KB, Mouse, Etc.)                | 0x40..0x47 – INT Group 1A |
| <b>010</b> |                  | VKY III – Channel A – AVEC (SOF, SOL, Collision, Etc.) | 0x1D – INT Group 0A       |
| <b>001</b> | Highest Priority | VKY III – Channel B – AVEC (SOF, SOL, Collision, Etc.) | 0x1E – INT Group 0B       |
| <b>000</b> | NMI              | Not Used   |                           |

9.1.5. Timer Controllers Registers

| Addy Start Offset | Addy End | Size | Type | R/W | Description  |
|-------------------|----------|------|------|-----|--|
| 0x0200            |          | 32   | I/O  | R/W | <b>Control Register 0 Value @ Reset: 0x0000_0000</b> |
| 0x0204            |          | 32   | I/O  | R/W | <b>Control Register 1 Value @ Reset: 0x0000_0000</b> |
| 0x0208            |          | 32   | I/O  | R/W | <b>Timer 0 Value (@ CPU Clock)</b>                   |
| 0x020C            |          | 32   | I/O  | R/W | <b>Timer 0 Compare</b>                               |
| 0x0210            |          | 32   | I/O  | R/W | <b>Timer 1 Value (@ CPU Clock)</b>                   |
| 0x0214            |          | 32   | I/O  | R/W | <b>Timer 1 Compare</b>                               |
| 0x0218            |          | 32   | I/O  | R/W | <b>Timer 2 Value (@ CPU Clock)</b>                   |
| 0x021C            |          | 32   | I/O  | R/W | <b>Timer 2 Compare</b>                               |
| 0x0220            |          | 32   | I/O  | R/W | <b>Timer 3 Value (@ SOF Clock Channel A)</b>         |
| 0x0224            |          | 32   | I/O  | R/W | <b>Timer 3 Compare</b>                               |
| 0x0228            |          | 32   | I/O  | R/W | <b>Timer 4 Value (@ SOF Clock Channel B)</b>         |
| 0x022C            |          | 32   | I/O  | R/W | <b>Timer 4 Compare</b>                               |

9.1.6. SD Card Controller Registers

| Addy Start Offset  | Addy End | Size | Type       | R/W | Description  |               |     |     |               |     |     |             |     |     |                   |   |   |                    |   |   |          |   |   |           |   |   |          |   |   |           |   |   |           |   |   |            |   |   |            |   |   |          |   |   |          |   |   |            |   |   |
|--------------------|----------|------|------------|-----|--|---------------|-----|-----|---------------|-----|-----|-------------|-----|-----|-------------------|---|---|--------------------|---|---|----------|---|---|-----------|---|---|----------|---|---|-----------|---|---|-----------|---|---|------------|---|---|------------|---|---|----------|---|---|----------|---|---|------------|---|---|
| 0x0300             |          | 8    | I/O        | R/W | <b>Version Reg</b><br><p>Major Revision Number [3] ← Bit 7<br/>                     Major Revision Number [2] ← Bit 6<br/>                     Major Revision Number [1] ← Bit 5<br/>                     Major Revision Number [0] ← Bit 4<br/>                     Minor Revision Number [0] ← Bit 2<br/>                     Minor Revision Number [1] ← Bit 1<br/>                     Minor Revision Number [2] ← Bit 0</p>   |               |     |     |               |     |     |             |     |     |                   |   |   |                    |   |   |          |   |   |           |   |   |          |   |   |           |   |   |           |   |   |            |   |   |            |   |   |          |   |   |          |   |   |            |   |   |
| 0x0301             |          | 8    | I/O        | R/W | <b>Master Control Register</b><br><p>Reserved ← Bit 7<br/>                     Reserved ← Bit 6<br/>                     Reserved ← Bit 5<br/>                     Reserved ← Bit 4<br/>                     Reserved ← Bit 3<br/>                     Reset Controller (1 = Reset) ← Bit 2<br/>                     Reserved ← Bit 1<br/>                     Reserved ← Bit 0</p>  |               |     |     |               |     |     |             |     |     |                   |   |   |                    |   |   |          |   |   |           |   |   |          |   |   |           |   |   |           |   |   |            |   |   |            |   |   |          |   |   |          |   |   |            |   |   |
| 0x0302             |          | 8    | I/O        | R/W | <b>Transfer Type</b><br><p>Reserved ← Bit 7<br/>                     Reserved ← Bit 6<br/>                     Reserved ← Bit 5<br/>                     Reserved ← Bit 4<br/>                     Reserved ← Bit 3<br/>                     Transfer Type[0] ← Bit 2<br/>                     Transfer Type[1] ← Bit 1<br/>                     Reserved ← Bit 0</p> <table border="1"> <thead> <tr> <th>Transfer Type</th> <th>[1]</th> <th>[0]</th> </tr> </thead> <tbody> <tr> <td>Direct Access</td> <td>0</td> <td>0</td> </tr> <tr> <td>Init SD</td> <td>0</td> <td>1</td> </tr> <tr> <td>R/W Read SD Block</td> <td>1</td> <td>0</td> </tr> <tr> <td>R/W Write SD Block</td> <td>1</td> <td>1</td> </tr> </tbody> </table>   | Transfer Type | [1] | [0] | Direct Access | 0   | 0   | Init SD     | 0   | 1   | R/W Read SD Block | 1 | 0 | R/W Write SD Block | 1 | 1 |          |   |   |           |   |   |          |   |   |           |   |   |           |   |   |            |   |   |            |   |   |          |   |   |          |   |   |            |   |   |
| Transfer Type      | [1]      | [0]  |            |     |  |               |     |     |               |     |     |             |     |     |                   |   |   |                    |   |   |          |   |   |           |   |   |          |   |   |           |   |   |           |   |   |            |   |   |            |   |   |          |   |   |          |   |   |            |   |   |
| Direct Access      | 0        | 0    |            |     |  |               |     |     |               |     |     |             |     |     |                   |   |   |                    |   |   |          |   |   |           |   |   |          |   |   |           |   |   |           |   |   |            |   |   |            |   |   |          |   |   |          |   |   |            |   |   |
| Init SD            | 0        | 1    |            |     |  |               |     |     |               |     |     |             |     |     |                   |   |   |                    |   |   |          |   |   |           |   |   |          |   |   |           |   |   |           |   |   |            |   |   |            |   |   |          |   |   |          |   |   |            |   |   |
| R/W Read SD Block  | 1        | 0    |            |     |  |               |     |     |               |     |     |             |     |     |                   |   |   |                    |   |   |          |   |   |           |   |   |          |   |   |           |   |   |           |   |   |            |   |   |            |   |   |          |   |   |          |   |   |            |   |   |
| R/W Write SD Block | 1        | 1    |            |     |  |               |     |     |               |     |     |             |     |     |                   |   |   |                    |   |   |          |   |   |           |   |   |          |   |   |           |   |   |           |   |   |            |   |   |            |   |   |          |   |   |          |   |   |            |   |   |
| 0x0303             |          | 8    | I/O        | R/W | <b>Transfer Control Register</b><br><p>Reserved ← Bit 7<br/>                     Reserved ← Bit 6<br/>                     Reserved ← Bit 5<br/>                     Reserved ← Bit 4<br/>                     Reserved ← Bit 3<br/>                     Start Transaction (Self-Clear) ← Bit 2<br/>                     Reserved ← Bit 1<br/>                     Reserved ← Bit 0</p>  |               |     |     |               |     |     |             |     |     |                   |   |   |                    |   |   |          |   |   |           |   |   |          |   |   |           |   |   |           |   |   |            |   |   |            |   |   |          |   |   |          |   |   |            |   |   |
| 0x0304             |          | 8    | I/O        | R   | <b>Transfer Status Register</b><br><p>Reserved ← Bit 7<br/>                     Reserved ← Bit 6<br/>                     Reserved ← Bit 5<br/>                     Reserved ← Bit 4<br/>                     Reserved ← Bit 3<br/>                     1 = Busy ← Bit 2<br/>                     Reserved ← Bit 1<br/>                     Reserved ← Bit 0</p>   |               |     |     |               |     |     |             |     |     |                   |   |   |                    |   |   |          |   |   |           |   |   |          |   |   |           |   |   |           |   |   |            |   |   |            |   |   |          |   |   |          |   |   |            |   |   |
| 0x0305             |          | 8    | I/O        | R/W | <b>Transfer Error Register</b><br><p>Reserved ← Bit 7<br/>                     Reserved ← Bit 6<br/>                     Reserved ← Bit 5<br/>                     Reserved ← Bit 4<br/>                     Reserved ← Bit 3<br/>                     SD_WRITE_ERROR[1] ← Bit 2<br/>                     SD_WRITE_ERROR[0] ← Bit 1<br/>                     SD_INIT_ERROR[0] ← Bit 0<br/>                     SD_INIT_ERROR[1] ← Bit 0<br/>                     SD_READ_ERROR[0] ← Bit 0<br/>                     SD_READ_ERROR[1] ← Bit 0</p> <table border="1"> <thead> <tr> <th>Init Error</th> <th>[1]</th> <th>[0]</th> <th>Read Error</th> <th>[1]</th> <th>[0]</th> <th>Write Error</th> <th>[1]</th> <th>[0]</th> </tr> </thead> <tbody> <tr> <td>No Error</td> <td>0</td> <td>0</td> <td>No Error</td> <td>0</td> <td>0</td> <td>No Error</td> <td>0</td> <td>0</td> </tr> <tr> <td>Init CMD0</td> <td>0</td> <td>1</td> <td>Read CMD</td> <td>0</td> <td>1</td> <td>Write CMD</td> <td>0</td> <td>1</td> </tr> <tr> <td>Init CMD1</td> <td>1</td> <td>0</td> <td>Read Token</td> <td>1</td> <td>0</td> <td>Write Data</td> <td>1</td> <td>0</td> </tr> <tr> <td>Reserved</td> <td>1</td> <td>1</td> <td>Reserved</td> <td>1</td> <td>1</td> <td>Write Busy</td> <td>X</td> <td>X</td> </tr> </tbody> </table> | Init Error    | [1] | [0] | Read Error    | [1] | [0] | Write Error | [1] | [0] | No Error          | 0 | 0 | No Error           | 0 | 0 | No Error | 0 | 0 | Init CMD0 | 0 | 1 | Read CMD | 0 | 1 | Write CMD | 0 | 1 | Init CMD1 | 1 | 0 | Read Token | 1 | 0 | Write Data | 1 | 0 | Reserved | 1 | 1 | Reserved | 1 | 1 | Write Busy | X | X |
| Init Error         | [1]      | [0]  | Read Error | [1] | [0]  | Write Error   | [1] | [0] |               |     |     |             |     |     |                   |   |   |                    |   |   |          |   |   |           |   |   |          |   |   |           |   |   |           |   |   |            |   |   |            |   |   |          |   |   |          |   |   |            |   |   |
| No Error           | 0        | 0    | No Error   | 0   | 0  | No Error      | 0   | 0   |               |     |     |             |     |     |                   |   |   |                    |   |   |          |   |   |           |   |   |          |   |   |           |   |   |           |   |   |            |   |   |            |   |   |          |   |   |          |   |   |            |   |   |
| Init CMD0          | 0        | 1    | Read CMD   | 0   | 1  | Write CMD     | 0   | 1   |               |     |     |             |     |     |                   |   |   |                    |   |   |          |   |   |           |   |   |          |   |   |           |   |   |           |   |   |            |   |   |            |   |   |          |   |   |          |   |   |            |   |   |
| Init CMD1          | 1        | 0    | Read Token | 1   | 0  | Write Data    | 1   | 0   |               |     |     |             |     |     |                   |   |   |                    |   |   |          |   |   |           |   |   |          |   |   |           |   |   |           |   |   |            |   |   |            |   |   |          |   |   |          |   |   |            |   |   |
| Reserved           | 1        | 1    | Reserved   | 1   | 1  | Write Busy    | X   | X   |               |     |     |             |     |     |                   |   |   |                    |   |   |          |   |   |           |   |   |          |   |   |           |   |   |           |   |   |            |   |   |            |   |   |          |   |   |          |   |   |            |   |   |
| 0x0306             |          | 8    | I/O        | R/W | <b>Direct Access Data Register</b><br><b>TX_Data[7:0] (W)</b><br>Set TX_DATA prior to starting a DIRECT_ACCESS transaction.<br><br>Note that the SPI bus has no concept of a read or write transaction. Thus every DIRECT_ACCESS transaction transmits data from the SPI master, and receives data from the SPI slave.<br><br><b>RX_Data[7:0] (R)</b><br>Read RX_DATA after completing a DIRECT_ACCESS transaction.  |               |     |     |               |     |     |             |     |     |                   |   |   |                    |   |   |          |   |   |           |   |   |          |   |   |           |   |   |           |   |   |            |   |   |            |   |   |          |   |   |          |   |   |            |   |   |
| 0x0307             |          | 8    | I/O        | R/W | <b>SD Address Register [7:0]</b><br>Normally set to zero, because memory accesses should occur on a 512 bytes boundary. Set the SD/MMC memory address before starting a block read or block write.   |               |     |     |               |     |     |             |     |     |                   |   |   |                    |   |   |          |   |   |           |   |   |          |   |   |           |   |   |           |   |   |            |   |   |            |   |   |          |   |   |          |   |   |            |   |   |

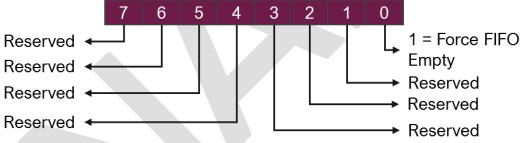
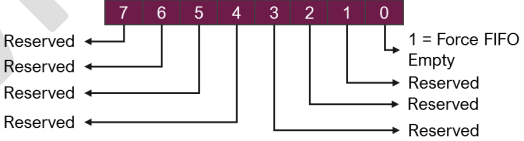

|               |  |          |            |            |  |
|---------------|--|----------|------------|------------|--|
| <b>0x0308</b> |  | <b>8</b> | <b>I/O</b> | <b>R/W</b> | <b>SD Address Register [15:8]</b><br>Normally set SD_ADDR[8] to zero, because memory accesses should occur on a 512 bytes boundary.  |
| <b>0x0309</b> |  | <b>8</b> | <b>I/O</b> | <b>R/W</b> | <b>SD Address Register [23:16]</b>   |
| <b>0x030A</b> |  | <b>8</b> | <b>I/O</b> | <b>R/W</b> | <b>SD Address Register [31:24]</b>   |
| <b>0x030B</b> |  | <b>8</b> | <b>I/O</b> | <b>R/W</b> | <b>SPI Clock Del Register</b><br>SPI_CLK_DEL controls the frequency of the SPI_CLK after SD initialization is completed.<br>$SPI\_CLK\_DEL = (spiSysClk / (SPI\_CLK * 2)) - 1$                     |
| <b>0x0310</b> |  | <b>8</b> | <b>I/O</b> | <b>R</b>   | <b>Reception FIFO Data Register</b><br>SD/MMC block read data.<br>Note, FIFO size matches the SD/MMC block size of 512 bytes.  |
| <b>0x0312</b> |  | <b>8</b> | <b>I/O</b> | <b>R/W</b> | <b>Reception FIFO Data Count Register [15:8]</b><br>MSB of FIFO_DATA_COUNT.<br>Indicates the number of data entries within the FIFO.   |
| <b>0x0313</b> |  | <b>8</b> | <b>I/O</b> | <b>R/W</b> | <b>Reception FIFO Data Count Register [7:0]</b><br>LSB of FIFO_DATA_COUNT.<br>Indicates the number of data entries within the FIFO.  |
| <b>0x0314</b> |  | <b>8</b> | <b>I/O</b> | <b>R/W</b> | <b>Reception FIFO Control Register</b>  <p>Deletes all the data samples within the FIFO. Self clearing.</p>      |
| <b>0x0320</b> |  | <b>8</b> | <b>I/O</b> | <b>R/W</b> | <b>Transmission FIFO Data Register</b><br>SD/MMC block write data.<br>FIFO size matches the SD/MMC block size of 512 bytes.  |
| <b>0x0324</b> |  | <b>8</b> | <b>I/O</b> | <b>R/W</b> | <b>Transmission FIFO Control Register</b>  <p>Deletes all the data samples within the FIFO. Self clearing.</p> |

### 9.1.7. IDE Control Registers

(For more detail on how to use the IDE, please consult the official PATA documentation)

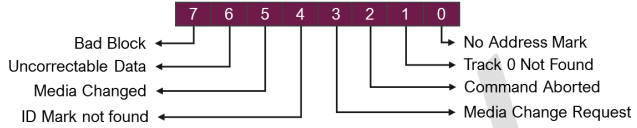
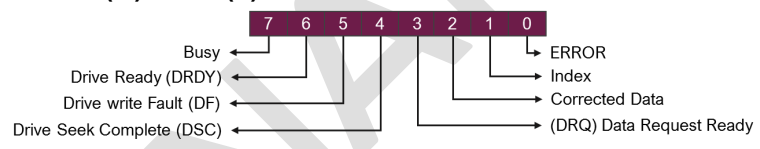
| Addy Start Offset | Addy End | Size | Type | R/W | Description  |
|-------------------|----------|------|------|-----|--|
| 0x0400            |          | 16   | I/O  | R/W | <b>IDE Data Register</b>   |
| 0x0402            |          | 8    | I/O  | R/W | <b>IDE Error</b>   |
| 0x0404            |          | 8    | I/O  | R/W | <b>IDE Sector CNT</b>  |
| 0x0406            |          | 8    | I/O  | R/W | <b>IDE Sector SRT / LBA0</b>   |
| 0x0408            |          | 8    | I/O  | R/W | <b>IDE Cylinder Low / LBA1</b>   |
| 0x040A            |          | 8    | I/O  | R/W | <b>IDE Cylinder Hi / LBA2</b>  |
| 0x040C            |          | 8    | I/O  | R/W | <b>IDE Head / DEVSEL</b>   |
| 0x040E            |          | 8    | I/O  | R/W | <b>IDE CMD (W) /STAT (R)</b>  <p>For the Command list, refer to the official PATA Documentation.</p> |
| 0x0410            |          | 8/16 | I/O  | R/W | <b>CS3 Register</b>  |

9.1.8. JOYSTICK Control Registers

| Addy Start Offset | Addy End | Size | Type | R/W | Description  |
|-------------------|----------|------|------|-----|--|
| 0x0500            |          | 16   | I/O  | R/W | <b>Atari Style DB9 Joystick Port 0 &amp; 1 Data Input</b>    |
| 0x0502            |          | 16   | I/O  | R   | Reserved - Reads: 0x0000                                     |
| 0x0504            |          | 16   | I/O  | R/W | <b>NES/SNES Control Register &amp; Status</b>                |
| 0x0506            |          | 16   | I/O  | R   | Reserved - Reads: 0x0000                                     |
| 0x0508            |          | 16   | I/O  | R   | <b>NES/SNES Port 0 - Input 0 (When using Joypad Adapter)</b> |
| 0x050A            |          | 16   | I/O  | R   | <b>NES/SNES Port 0 - Input 1 (When using Joypad Adapter)</b> |
| 0x050C            |          | 16   | I/O  | R   | <b>NES/SNES Port 0 - Input 2 (When using Joypad Adapter)</b> |
| 0x050E            |          | 16   | I/O  | R   | <b>NES/SNES Port 0 - Input 3 (When using Joypad Adapter)</b> |
| 0x0510            |          | 16   | I/O  | R   | <b>NES/SNES Port 1 - Input 0 (When using Joypad Adapter)</b> |
| 0x0512            |          | 16   | I/O  | R   | <b>NES/SNES Port 1 - Input 1 (When using Joypad Adapter)</b> |
| 0x0514            |          | 16   | I/O  | R   | <b>NES/SNES Port 1 - Input 2 (When using Joypad Adapter)</b> |
| 0x0516            |          | 16   | I/O  | R   | <b>NES/SNES Port 1 - Input 3 (When using Joypad Adapter)</b> |

|                      |  |                  |                   |                 |  |
|----------------------|--|------------------|-------------------|-----------------|--|
| <p><b>0x0518</b></p> |  | <p><b>16</b></p> | <p><b>I/O</b></p> | <p><b>R</b></p> | <p><b>DIP Switch Value</b></p>                                     |
| <p><b>0x051A</b></p> |  | <p><b>16</b></p> | <p><b>I/O</b></p> | <p><b>R</b></p> | <p><b>SD Card Write Protect &amp; Card Detect Switch Value</b></p> |
| <p><b>0x051C</b></p> |  | <p><b>16</b></p> | <p><b>I/O</b></p> | <p><b>R</b></p> | <p><b>Reserved</b> - Reads: 0x5555</p>                             |
| <p><b>0x051E</b></p> |  | <p><b>16</b></p> | <p><b>I/O</b></p> | <p><b>R</b></p> | <p><b>Reserved</b> - Reads: 0xAAAA</p>                             |

PRELIMINARY

### 9.1.9. Ethernet Controller - LAN9221

(See datasheet for all details on all registers)

| Addy Start Offset | Addy End | Size | Type | R/W | Description                                 |
|-------------------|----------|------|------|-----|---|
| 0x0600            | 0x64F    | 32   | I/O  | R/W | FIFO Ports (See Datasheet for more details) |
| 0x0650            |          | 32   | I/O  | R/W | Chip ID & Revision                          |
| 0x0654            |          | 32   | I/O  | R/W | Main Interrupt Configuration                |
| 0x0658            |          | 32   | I/O  | R/W | Interrupt Status                            |
| 0x065C            |          | 32   | I/O  | R/W | Interrupt Enable Register                   |
| 0x0660            |          | 32   | I/O  |     | Reserved                                    |
| 0x0664            |          | 32   | I/O  | R   | Read Only Byte Ordering                     |
| 0x0668            |          | 32   | I/O  | R/W | FIFO Level Interrupt                        |
| 0x066C            |          | 32   | I/O  | R/W | Rx Configuration                            |
| 0x0670            |          | 32   | I/O  | R/W | Tx Configuration                            |
| 0x0674            |          | 32   | I/O  | R/W | Hardware Configuration                      |
| 0x0678            |          | 32   | I/O  | R/W | Rx Datapath Control                         |
| 0x067C            |          | 32   | I/O  | R/W | Rx FIFO Information                         |
| 0x0680            |          | 32   | I/O  | R/W | Tx FIFO Information                         |
| 0x0684            |          | 32   | I/O  | R/W | Power Management Control                    |
| 0x0688            |          | 32   | I/O  | R/W | General Purpose IO Configuration            |
| 0x068C            |          | 32   | I/O  | R/W | General Purpose Timer Configuration         |
| 0x0690            |          | 32   | I/O  | R/W | General Purpose Timer Count                 |
| 0x0694            |          | 32   | I/O  |     | Reserved                                    |
| 0x0698            |          | 32   | I/O  | R/W | Word Swap Register                          |
| 0x069C            |          | 32   | I/O  | R/W | Free Run Counter                            |
| 0x06A0            |          | 32   | I/O  | R/W | Rx Dropped Frame Counter                    |
| 0x06A4            |          | 32   | I/O  | R/W | MAC CSR Synchronizer Command                |
| 0x06A8            |          | 32   | I/O  | R/W | MAC CSR Synchronizer Data                   |
| 0x06AC            |          | 32   | I/O  | R/W | Automatic Flow Control Config               |
| 0x06B0            |          | 32   | I/O  | R/W | EEPROM Command                              |
| 0x06B4            |          | 32   | I/O  | R/W | EEPROM Data                                 |
| 0x06B8            | 0x06FC   | 32   | I/O  |     | Reserved for Future Use                     |

### 9.1.10. Mau's ARGB Matrix Memory Block

| Addy Start Offset | Addy End | Size | Type | R/W | Description  |
|-------------------|----------|------|------|-----|--|
| 0x1000            | 0x100F   | 16   | MEM  | W   | Row 1 x (ARGB) [AAAA <b>RRRR</b> GGGG <b>BBBB</b> ] 16 LOI - Space bar Row                                     |
| 0x1010            | 0x101F   | 16   | MEM  | W   | Row 2 x (ARGB) [AAAA <b>RRRR</b> GGGG <b>BBBB</b> ] 16 LOI per color   |
| 0x1020            | 0x102F   | 16   | MEM  | W   | Row 3 x (ARGB) [AAAA <b>RRRR</b> GGGG <b>BBBB</b> ] 16 LOI per color   |
| 0x1030            | 0x103F   | 16   | MEM  | W   | Row 4 x (ARGB) [AAAA <b>RRRR</b> GGGG <b>BBBB</b> ] 16 LOI per color   |
| 0x1040            | 0x104F   | 16   | MEM  | W   | Row 5 x (ARGB) [AAAA <b>RRRR</b> GGGG <b>BBBB</b> ] 16 LOI per color   |
| 0x1050            | 0x105F   | 16   | MEM  | W   | Row 6 x (ARGB) [AAAA <b>RRRR</b> GGGG <b>BBBB</b> ] 16 LOI per color   |
|                   |          |      |      |     | 6 Row x 16 Column Matrix with 16bits Per LED.<br>Note: (The matrix is not full and is not necessarily aligned) |

9.1.11. SUPER IO - LPC47M107

(See LPC47M107 datasheet for all details on all registers)

| Address Start Offset                  | Address End | Size | Type | R/W | Description   |
|---------------------------------------|-------------|------|------|-----|---|
| <b>Official (8042) PS2 Controller</b> |             |      |      |     |   |
| 0x2060                                |             | 8    | I/O  | R/W | Keyboard/Mouse Output Buffer (W)<br>Keyboard/Mouse Input Buffer (R)<br>Keyboard/Mouse Data Buffer (R/W) |
| 0x2064                                |             | 8    | I/O  | R/W | Keyboard/Mouse Status Port (R)<br>Keyboard/Mouse CMD Port (W)   |
| <b>Game Port</b>                      |             |      |      |     |   |
| 0x2200                                |             | 8    | I/O  | R/W | Analog Joystick Data Port (see datasheet)   |
| <b>Serial COM2</b>                    |             |      |      |     |   |
| 0x2278                                |             | 8    | I/O  | R/W | (RHR) Receiver Holding Register (R)<br>(THR) Transmitter Holding Register (W)                           |
| 0x2279                                |             | 8    | I/O  | R/W | (IER) Interrupt Enable Register   |
| 0x227A                                |             | 8    | I/O  | R/W | (ISR) Interrupt Status Register (R)<br>(FCR) FIFO Control Register (FIFO is 16 Bytes Deep) (W)          |
| 0x227B                                |             | 8    | I/O  | R/W | (LCR) Line Control Register   |
| 0x227C                                |             | 8    | I/O  | R/W | (MCR) Modem Control Register  |
| 0x227D                                |             | 8    | I/O  | R   | (LSR) Line Status Register  |
| 0x227E                                |             | 8    | I/O  | R/W | (MSR) Modem Status Register   |
| 0x227F                                |             | 8    | I/O  | R/W | (SPR) Scratch Pad Register  |
| <b>When DLAB = 1</b>                  |             |      |      |     |   |
| 0x2278                                |             | 8    | I/O  | R/W | (DLL) Baud rate Divisor's Constant LSB  |
| 0x2279                                |             | 8    | I/O  | R/W | (DLM) Baud rate Divisor's Constant MSB  |
| <b>MPU-401 (MIDI)</b>                 |             |      |      |     |   |
| 0x2330                                |             | 8    | I/O  | R/W | MIDI Data   |
| 0x2331                                |             | 8    | I/O  | R   | Status  |
| 0x2331                                |             | 8    | I/O  | W   | Command   |
| <b>Parallel Port LPT1</b>             |             |      |      |     |   |
| 0x2378                                | 0x237F      | 8    | I/O  | R/W | See all the details in the Datasheet  |
| <b>FDC Controller</b>                 |             |      |      |     |   |
| 0x23F0                                | 0x23F7      | 8    | I/O  | R/W | See all the details in the Datasheet  |
| <b>Serial COM1</b>                    |             |      |      |     |   |
| 0x23F8                                |             | 8    | I/O  | R/W | (RHR) Receiver Holding Register (R)<br>(THR) Transmitter Holding Register (W)                           |
| 0x23F9                                |             | 8    | I/O  | R/W | (IER) Interrupt Enable Register   |
| 0x23FA                                |             | 8    | I/O  | R/W | (ISR) Interrupt Status Register (R)<br>(FCR) FIFO Control Register (FIFO is 16 Bytes Deep) (W)          |
| 0x23FB                                |             | 8    | I/O  | R/W | (LCR) Line Control Register   |
| 0x23FC                                |             | 8    | I/O  | R/W | (MCR) Modem Control Register  |
| 0x23FD                                |             | 8    | I/O  | R   | (LSR) Line Status Register  |
| 0x23FE                                |             | 8    | I/O  | R/W | (MSR) Modem Status Register   |
| 0x23FF                                |             | 8    | I/O  | R/W | (SPR) Scratch Pad Register  |
| <b>When DLAB = 1</b>                  |             |      |      |     |   |
| 0x23F8                                |             | 8    | I/O  | R/W | (DLL) Baud rate Divisor's Constant LSB  |
| 0x23F9                                |             | 8    | I/O  | R/W | (DLM) Baud rate Divisor's Constant MSB  |

## 9.1.12. Fixed Math Block

| Addy Start Offset              | Addy End | Size | Type | R/W | Description             |
|--------------------------------|----------|------|------|-----|-------------------------|
| <b>UNSIGNED MULTIPLICATION</b> |          |      |      |     |                         |
| 0x3000                         |          | 32   | I/O  | R/W | Operand A               |
| 0x3004                         |          | 32   | I/O  | R/W | Operand B               |
| 0x3008                         |          | 32   | I/O  | R/W | Results [31:0] Low      |
| 0x300C                         |          | 32   | I/O  | R/W | Results [63:32] Hi      |
| <b>SIGNED MULTIPLICATION</b>   |          |      |      |     |                         |
| 0x3020                         |          | 32   | I/O  | R/W | Operand A               |
| 0x3024                         |          | 32   | I/O  | R/W | Operand B               |
| 0x3028                         |          | 32   | I/O  | R/W | Results [31:0] Low      |
| 0x302C                         |          | 32   | I/O  | R/W | Results [63:32] Hi      |
| <b>UNSIGNED DIVISION</b>       |          |      |      |     |                         |
| 0x3040                         |          | 32   | I/O  | R/W | Operand A               |
| 0x3044                         |          | 32   | I/O  | R/W | Operand B               |
| 0x3048                         |          | 32   | I/O  | R/W | Quotient Results [31:0] |
| 0x304C                         |          | 32   | I/O  | R/W | Remain Results [31:0]   |
| <b>SIGNED DIVISION</b>         |          |      |      |     |                         |
| 0x3060                         |          | 32   | I/O  | R/W | Operand A               |
| 0x3064                         |          | 32   | I/O  | R/W | Operand B               |
| 0x3068                         |          | 32   | I/O  | R/W | Quotient Results [31:0] |
| 0x306C                         |          | 32   | I/O  | R/W | Remain Results [31:0]   |

9.1.13. Floating Point Math Block

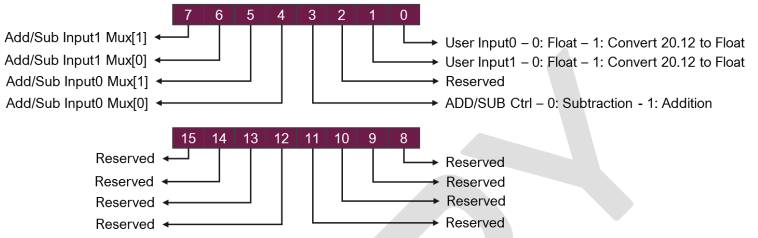
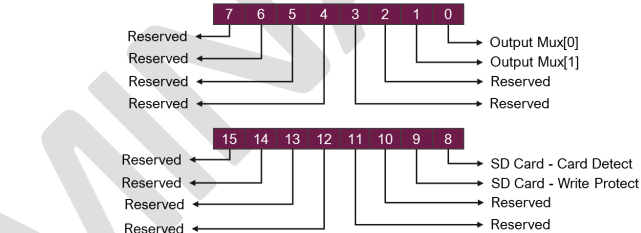
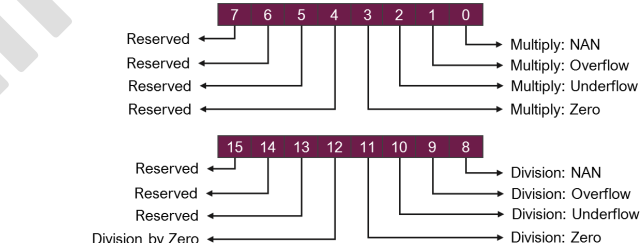
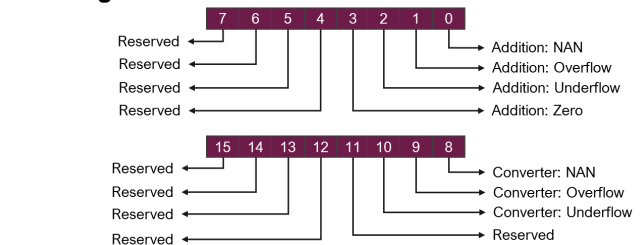
| Addy Start Offset        | Addy End | Size      | Type         | R/W        | Description  |                    |     |     |             |     |     |            |     |     |             |   |   |             |   |   |              |   |   |             |   |   |             |   |   |              |   |   |              |   |   |              |   |   |             |   |   |              |   |   |              |   |   |                    |   |   |
|--------------------------|----------|-----------|--------------|------------|--|--------------------|-----|-----|-------------|-----|-----|------------|-----|-----|-------------|---|---|-------------|---|---|--------------|---|---|-------------|---|---|-------------|---|---|--------------|---|---|--------------|---|---|--------------|---|---|-------------|---|---|--------------|---|---|--------------|---|---|--------------------|---|---|
| <b>Control Registers</b> |          |           |              |            |  |                    |     |     |             |     |     |            |     |     |             |   |   |             |   |   |              |   |   |             |   |   |             |   |   |              |   |   |              |   |   |              |   |   |             |   |   |              |   |   |              |   |   |                    |   |   |
| <b>0x4000</b>            |          | <b>16</b> | <b>I/O</b>   | <b>R/W</b> | <b>Control Register 0</b>  <table border="1" data-bbox="695 682 1464 787"> <thead> <tr> <th>Input0 Mux</th> <th>[1]</th> <th>[0]</th> <th>Input 1 Mux</th> <th>[1]</th> <th>[0]</th> <th>Output Mux</th> <th>[1]</th> <th>[0]</th> </tr> </thead> <tbody> <tr> <td>Input Mux 0</td> <td>0</td> <td>0</td> <td>Input Mux 0</td> <td>0</td> <td>0</td> <td>Multiply Out</td> <td>0</td> <td>0</td> </tr> <tr> <td>Input Mux 1</td> <td>0</td> <td>1</td> <td>Input Mux 1</td> <td>0</td> <td>1</td> <td>Division Out</td> <td>0</td> <td>1</td> </tr> <tr> <td>Multiply Out</td> <td>1</td> <td>0</td> <td>Multiply Out</td> <td>1</td> <td>0</td> <td>Add/Sub Out</td> <td>1</td> <td>0</td> </tr> <tr> <td>Division Out</td> <td>1</td> <td>1</td> <td>Division Out</td> <td>1</td> <td>1</td> <td>Value '1' in Float</td> <td>1</td> <td>1</td> </tr> </tbody> </table> | Input0 Mux         | [1] | [0] | Input 1 Mux | [1] | [0] | Output Mux | [1] | [0] | Input Mux 0 | 0 | 0 | Input Mux 0 | 0 | 0 | Multiply Out | 0 | 0 | Input Mux 1 | 0 | 1 | Input Mux 1 | 0 | 1 | Division Out | 0 | 1 | Multiply Out | 1 | 0 | Multiply Out | 1 | 0 | Add/Sub Out | 1 | 0 | Division Out | 1 | 1 | Division Out | 1 | 1 | Value '1' in Float | 1 | 1 |
| Input0 Mux               | [1]      | [0]       | Input 1 Mux  | [1]        | [0]  | Output Mux         | [1] | [0] |             |     |     |            |     |     |             |   |   |             |   |   |              |   |   |             |   |   |             |   |   |              |   |   |              |   |   |              |   |   |             |   |   |              |   |   |              |   |   |                    |   |   |
| Input Mux 0              | 0        | 0         | Input Mux 0  | 0          | 0  | Multiply Out       | 0   | 0   |             |     |     |            |     |     |             |   |   |             |   |   |              |   |   |             |   |   |             |   |   |              |   |   |              |   |   |              |   |   |             |   |   |              |   |   |              |   |   |                    |   |   |
| Input Mux 1              | 0        | 1         | Input Mux 1  | 0          | 1  | Division Out       | 0   | 1   |             |     |     |            |     |     |             |   |   |             |   |   |              |   |   |             |   |   |             |   |   |              |   |   |              |   |   |              |   |   |             |   |   |              |   |   |              |   |   |                    |   |   |
| Multiply Out             | 1        | 0         | Multiply Out | 1          | 0  | Add/Sub Out        | 1   | 0   |             |     |     |            |     |     |             |   |   |             |   |   |              |   |   |             |   |   |             |   |   |              |   |   |              |   |   |              |   |   |             |   |   |              |   |   |              |   |   |                    |   |   |
| Division Out             | 1        | 1         | Division Out | 1          | 1  | Value '1' in Float | 1   | 1   |             |     |     |            |     |     |             |   |   |             |   |   |              |   |   |             |   |   |             |   |   |              |   |   |              |   |   |              |   |   |             |   |   |              |   |   |              |   |   |                    |   |   |
| <b>0x4002</b>            |          | <b>16</b> | <b>I/O</b>   | <b>R/W</b> | <b>Control Register 1</b>   |                    |     |     |             |     |     |            |     |     |             |   |   |             |   |   |              |   |   |             |   |   |             |   |   |              |   |   |              |   |   |              |   |   |             |   |   |              |   |   |              |   |   |                    |   |   |
| <b>Status Registers</b>  |          |           |              |            |  |                    |     |     |             |     |     |            |     |     |             |   |   |             |   |   |              |   |   |             |   |   |             |   |   |              |   |   |              |   |   |              |   |   |             |   |   |              |   |   |              |   |   |                    |   |   |
| <b>0x4004</b>            |          | <b>16</b> | <b>I/O</b>   | <b>R</b>   | <b>Status Register 0</b>   |                    |     |     |             |     |     |            |     |     |             |   |   |             |   |   |              |   |   |             |   |   |             |   |   |              |   |   |              |   |   |              |   |   |             |   |   |              |   |   |              |   |   |                    |   |   |
| <b>0x4006</b>            |          | <b>16</b> | <b>I/O</b>   | <b>R</b>   | <b>Status Register 1</b>   |                    |     |     |             |     |     |            |     |     |             |   |   |             |   |   |              |   |   |             |   |   |             |   |   |              |   |   |              |   |   |              |   |   |             |   |   |              |   |   |              |   |   |                    |   |   |
| <b>User Input</b>        |          |           |              |            |  |                    |     |     |             |     |     |            |     |     |             |   |   |             |   |   |              |   |   |             |   |   |             |   |   |              |   |   |              |   |   |              |   |   |             |   |   |              |   |   |              |   |   |                    |   |   |
| <b>0x4008</b>            |          | <b>32</b> | <b>I/O</b>   | <b>W</b>   | <b>User Input 0 (IEEE Float Input or 20.12 Fixed-Point Input)</b>  |                    |     |     |             |     |     |            |     |     |             |   |   |             |   |   |              |   |   |             |   |   |             |   |   |              |   |   |              |   |   |              |   |   |             |   |   |              |   |   |              |   |   |                    |   |   |
| <b>0x400C</b>            |          | <b>32</b> | <b>I/O</b>   | <b>W</b>   | <b>User Input 1 (IEEE Float Input or 20.12 Fixed-Point Input)</b>  |                    |     |     |             |     |     |            |     |     |             |   |   |             |   |   |              |   |   |             |   |   |             |   |   |              |   |   |              |   |   |              |   |   |             |   |   |              |   |   |              |   |   |                    |   |   |
| <b>User Output</b>       |          |           |              |            |  |                    |     |     |             |     |     |            |     |     |             |   |   |             |   |   |              |   |   |             |   |   |             |   |   |              |   |   |              |   |   |              |   |   |             |   |   |              |   |   |              |   |   |                    |   |   |
| <b>0x4008</b>            |          | <b>32</b> | <b>I/O</b>   | <b>R</b>   | <b>User Output (IEEE Float Output)</b>   |                    |     |     |             |     |     |            |     |     |             |   |   |             |   |   |              |   |   |             |   |   |             |   |   |              |   |   |              |   |   |              |   |   |             |   |   |              |   |   |              |   |   |                    |   |   |
| <b>0x400C</b>            |          | <b>32</b> | <b>I/O</b>   | <b>R</b>   | <b>User Output (Fixed-Point 20.12 Output)</b>  |                    |     |     |             |     |     |            |     |     |             |   |   |             |   |   |              |   |   |             |   |   |             |   |   |              |   |   |              |   |   |              |   |   |             |   |   |              |   |   |              |   |   |                    |   |   |



9.2. BEATRIX Address Offset: 0xFEC2:XXXX

9.2.1. BEATRIX Control Registers

| Addr Start Offset | Addr End | Size | Type | R/W | Description |
|-------------------|----------|------|------|-----|-------------|
| 0x0000            |          |      | I/O  | R/W | TBD         |
| 0x0000            |          |      | I/O  | R/W | TBD         |
| 0x0000            |          |      | I/O  | R/W | TBD         |
| 0x0000            |          |      | I/O  | R/W | TBD         |
| 0x0000            |          |      | I/O  | R/W | TBD         |
| 0x0000            |          |      | I/O  | R/W | TBD         |
| 0x0000            |          |      | I/O  | R/W | TBD         |
| 0x0000            |          |      | I/O  | R/W | TBD         |
| 0x0000            |          |      | I/O  | R/W | TBD         |
| 0x0000            |          |      | I/O  | R/W | TBD         |
| 0x0000            |          |      | I/O  | R/W | TBD         |
| 0x0000            |          |      | I/O  | R/W | TBD         |
| 0x0000            |          |      | I/O  | R/W | TBD         |
| 0x0000            |          |      | I/O  | R/W | TBD         |

PRELIMINARY

### 9.2.2. PSG - SN76489 - Control Registers

(For Detailed information about the part's registers, please consult the SN76489 Datasheet)

| Addy Start Offset   | Addy End | Size | Type | R/W | Description                         |
|---|----------|------|------|-----|-------------------------------------|
| 0x0110  |          | 8    | I/O  | W   | External PSG – Mono Output          |
| 0x0110  |          | 8    | I/O  | W   | Internal (FPGA) PSG – LEFT Channel  |
| 0x0120  |          | 8    | I/O  | W   | Internal (FPGA) PSG – RIGHT Channel |
| 0x0130  |          | 8    | I/O  | W   | Internal (FPGA) PSG – MONO Channel  |
| When writing here, both Channels are written to at the same time. |          |      |      |     |                                     |

### 9.2.3. External OPL3 Control Registers

(For Detailed information about the part's registers, please consult the OPL3 Datasheet)

| Addy Start Offset                           | Addy End | Size | Type | R/W | Description        |
|---|----------|------|------|-----|--------------------|
| <b>RIGHT Channel (Registers summarized)</b> |          |      |      |     |                    |
| 0x0201                                      |          | 8    | I/O  | W   | TEST               |
| 0x0202                                      |          | 8    | I/O  | W   | TIMER-1            |
| 0x0203                                      |          | 8    | I/O  | W   | TIMER-2            |
| 0x0204                                      |          | 8    | I/O  | W   | IRQ                |
| 0x0205                                      |          | 8    | I/O  | W   | Set OPL3 Mode      |
| 0x0208                                      |          | 8    | I/O  | W   | CSM                |
| 0x0220                                      |          | 8    | I/O  | W   | AM/VID/EG/KSR/MULT |
| 0x0240                                      |          | 8    | I/O  | W   | KSL/TL             |
| 0x0260                                      |          | 8    | I/O  | W   | AR/DR              |
| 0x0280                                      |          | 8    | I/O  | W   | SL/RR              |
| 0x02A0                                      |          | 8    | I/O  | W   | F-Number           |
| 0x02B0                                      |          | 8    | I/O  | W   | KON/BLOCK/F-Number |
| 0x02BD                                      |          | 8    | I/O  | W   | DEPTH/Rythm        |
| 0x02C0                                      |          | 8    | I/O  | W   | FEEDBACK           |
| 0x02E0                                      |          | 8    | I/O  | W   | WAVE/SELECT        |
| <b>LEFT Channel (Registers summarized)</b>  |          |      |      |     |                    |
| 0x0301                                      |          | 8    | I/O  | W   | TEST               |
| 0x0302                                      |          | 8    | I/O  | W   | TIMER-1            |
| 0x0303                                      |          | 8    | I/O  | W   | TIMER-2            |
| 0x0304                                      |          | 8    | I/O  | W   | IRQ                |
| 0x0305                                      |          | 8    | I/O  | W   |                    |
| 0x0308                                      |          | 8    | I/O  | W   | CSM                |
| 0x0320                                      |          | 8    | I/O  | W   | AM/VID/EG/KSR/MULT |
| 0x0340                                      |          | 8    | I/O  | W   | KSL/TL             |
| 0x0360                                      |          | 8    | I/O  | W   | AR/DR              |
| 0x0380                                      |          | 8    | I/O  | W   | SL/RR              |
| 0x03A0                                      |          | 8    | I/O  | W   | F-Number           |
| 0x03B0                                      |          | 8    | I/O  | W   | KON/BLOCK/F-Number |
| 0x03BD                                      |          | 8    | I/O  | W   | DEPTH/Rythm        |
| 0x03C0                                      |          | 8    | I/O  | W   | FEEDBACK           |
| 0x03E0                                      |          | 8    | I/O  | W   | WAVE/SELECT        |

### 9.2.4. External OPN2 Control Registers

(For Detailed information about the part's registers, please consult the OPN2 Datasheet)

| Addy Start Offset | Addy End | Size | Type | R/W | Description   |
|-------------------|----------|------|------|-----|---|
| 0x0400            | 0x05FF   | 8    | I/O  | W   | Please consult Datasheet for the Details of the registers |

### 9.2.5. External OPM Control Registers

(For Detailed information about the part's registers, please consult the OPM Datasheet)

| Addy Start Offset | Addy End | Size | Type | R/W | Description   |
|-------------------|----------|------|------|-----|---|
| 0x0600            | 0x07FF   | 8    | I/O  | W   | Please consult Datasheet for the Details of the registers |

### 9.2.6. External Left SID Control Registers

(For Detailed information about the part's registers, please consult the CBM6581 Datasheet)

| Addy Start Offset                          | Addy End | Size | Type | R/W | Description                 |
|--|----------|------|------|-----|-----------------------------|
| <b>LEFT Channel (Registers summarized)</b> |          |      |      |     |                             |
| 0x0800                                     |          | 8    | I/O  | R/W | Voice 1 - FREQ LOW          |
| 0x0801                                     |          | 8    | I/O  | R/W | Voice 1 - FREQ HI           |
| 0x0802                                     |          | 8    | I/O  | R/W | Voice 1 - PW LO             |
| 0x0803                                     |          | 8    | I/O  | R/W | Voice 1 - PW HI             |
| 0x0804                                     |          | 8    | I/O  | R/W | Voice 1 - Control           |
| 0x0805                                     |          | 8    | I/O  | R/W | Voice 1 - Attack / Decay    |
| 0x0806                                     |          | 8    | I/O  | R/W | Voice 1 - Sustain / Release |
| 0x0807                                     |          | 8    | I/O  | R/W | Voice 2 - FREQ LOW          |
| 0x0808                                     |          | 8    | I/O  | R/W | Voice 2 - FREQ HI           |
| 0x0809                                     |          | 8    | I/O  | R/W | Voice 2 - PW LO             |
| 0x080A                                     |          | 8    | I/O  | R/W | Voice 2 - PW HI             |
| 0x080B                                     |          | 8    | I/O  | R/W | Voice 2 - Control           |
| 0x080C                                     |          | 8    | I/O  | R/W | Voice 2 - Attack / Decay    |
| 0x080D                                     |          | 8    | I/O  | R/W | Voice 2 - Sustain / Release |
| 0x080E                                     |          | 8    | I/O  | R/W | Voice 3 - FREQ LOW          |
| 0x080F                                     |          | 8    | I/O  | R/W | Voice 3 - FREQ HI           |
| 0x0810                                     |          | 8    | I/O  | R/W | Voice 3 - PW LO             |
| 0x0811                                     |          | 8    | I/O  | R/W | Voice 3 - PW HI             |
| 0x0812                                     |          | 8    | I/O  | R/W | Voice 3 - Control           |
| 0x0813                                     |          | 8    | I/O  | R/W | Voice 3 - Attack / Decay    |
| 0x0814                                     |          | 8    | I/O  | R/W | Voice 3 - Sustain / Release |
| 0x0815                                     |          | 8    | I/O  | R/W | Filter - FC LOW             |
| 0x0816                                     |          | 8    | I/O  | R/W | Filter - FC HI              |
| 0x0817                                     |          | 8    | I/O  | R/W | Filter - RES / FILT         |
| 0x0818                                     |          | 8    | I/O  | R/W | Filter - Mode / VOL         |
| 0x0819                                     |          | 8    | I/O  | R/W | POT X (not Supported)       |
| 0x081A                                     |          | 8    | I/O  | R/W | POT Y (not Supported)       |
| 0x081B                                     |          | 8    | I/O  | R/W | OSC3 / RANDOM               |

|        |  |   |     |     |          |
|--------|--|---|-----|-----|----------|
| 0x081C |  | 8 | I/O | R/W | ENV3     |
| 0x081D |  | 8 | I/O | R/W | Reserved |
| 0x081E |  | 8 | I/O | R/W | Reserved |
| 0x081F |  | 8 | I/O | R/W | Reserved |

### 9.2.7. External Right SID Control Registers

(For Detailed information about the part's registers, please consult the CBM6581 Datasheet)

| Addy Start Offset                          | Addy End | Size | Typ e | R/W | Description                 |
|--|----------|------|-------|-----|-----------------------------|
| <b>LEFT Channel (Registers summarized)</b> |          |      |       |     |                             |
| 0x0900                                     |          | 8    | I/O   | R/W | Voice 1 - FREQ LOW          |
| 0x0901                                     |          | 8    | I/O   | R/W | Voice 1 - FREQ HI           |
| 0x0902                                     |          | 8    | I/O   | R/W | Voice 1 - PW LO             |
| 0x0903                                     |          | 8    | I/O   | R/W | Voice 1 - PW HI             |
| 0x0904                                     |          | 8    | I/O   | R/W | Voice 1 - Control           |
| 0x0905                                     |          | 8    | I/O   | R/W | Voice 1 - Attack / Decay    |
| 0x0906                                     |          | 8    | I/O   | R/W | Voice 1 - Sustain / Release |
| 0x0907                                     |          | 8    | I/O   | R/W | Voice 2 - FREQ LOW          |
| 0x0908                                     |          | 8    | I/O   | R/W | Voice 2 - FREQ HI           |
| 0x0909                                     |          | 8    | I/O   | R/W | Voice 2 - PW LO             |
| 0x090A                                     |          | 8    | I/O   | R/W | Voice 2 - PW HI             |
| 0x090B                                     |          | 8    | I/O   | R/W | Voice 2 - Control           |
| 0x090C                                     |          | 8    | I/O   | R/W | Voice 2 - Attack / Decay    |
| 0x090D                                     |          | 8    | I/O   | R/W | Voice 2 - Sustain / Release |
| 0x090E                                     |          | 8    | I/O   | R/W | Voice 3 - FREQ LOW          |
| 0x090F                                     |          | 8    | I/O   | R/W | Voice 3 - FREQ HI           |
| 0x0910                                     |          | 8    | I/O   | R/W | Voice 3 - PW LO             |
| 0x0911                                     |          | 8    | I/O   | R/W | Voice 3 - PW HI             |
| 0x0912                                     |          | 8    | I/O   | R/W | Voice 3 - Control           |
| 0x0913                                     |          | 8    | I/O   | R/W | Voice 3 - Attack / Decay    |
| 0x0914                                     |          | 8    | I/O   | R/W | Voice 3 - Sustain / Release |
| 0x0915                                     |          | 8    | I/O   | R/W | Filter - FC LOW             |
| 0x0916                                     |          | 8    | I/O   | R/W | Filter - FC HI              |
| 0x0917                                     |          | 8    | I/O   | R/W | Filter - RES / FILT         |
| 0x0918                                     |          | 8    | I/O   | R/W | Filter - Mode / VOL         |
| 0x0919                                     |          | 8    | I/O   | R/W | POT X (not Supported)       |
| 0x091A                                     |          | 8    | I/O   | R/W | POT Y (not Supported)       |
| 0x091B                                     |          | 8    | I/O   | R/W | OSC3 / RANDOM               |
| 0x091C                                     |          | 8    | I/O   | R/W | ENV3                        |
| 0x091D                                     |          | 8    | I/O   | R/W | Reserved                    |
| 0x091E                                     |          | 8    | I/O   | R/W | Reserved                    |
| 0x091F                                     |          | 8    | I/O   | R/W | Reserved                    |

### 9.2.8. Internal QPN2 Control Registers

(For Detailed information about the part's registers, please consult the QPN2 Datasheet)

| Addy Start Offset | Addy End | Size | Type | R/W | Description   |
|-------------------|----------|------|------|-----|---|
| 0x0A00            | 0x0BFF   | 8    | I/O  | W   | Please consult Datasheet for the Details of the registers |

### 9.2.9. Internal QPM Control Registers

(For Detailed information about the part's registers, please consult the QPM Datasheet)

| Addy Start Offset | Addy End | Size | Type | R/W | Description   |
|-------------------|----------|------|------|-----|---|
| 0x0C00            | 0x0DFF   | 8    | I/O  | W   | Please consult Datasheet for the Details of the registers |

### 9.2.10. CODEC Control Registers

(For Detailed information about the part's registers, please consult the WM18776SEFT/U Datasheet)

| Addy Start Offset | Addy End | Size | Type | R/W | Description  |
|-------------------|----------|------|------|-----|--|
| 0x0E00            |          | 16   | I/O  | W   | <b>DATA Register</b><br>(Data is serialized to the CODEC after the Write Transaction is completed)<br>Consult the datasheet on how to form the data stream to be able to control the chip. |
| 0x0E00            |          | 16   | I/O  | R   | <b>STATUS</b> <p>Check for the busy flag to go back to '0' before sending another command</p>  |

### 9.2.11. Internal SIDs Control Registers

(For Detailed information about the part's registers, please consult the CBM6581 Datasheet)

| Addy Start Offset                           | Addy End | Size | Type | R/W | Description                 |
|---|----------|------|------|-----|-----------------------------|
| <b>LEFT Channel (Registers summarized)</b>  |          |      |      |     |                             |
| 0x1000                                      |          | 8    | I/O  | R/W | Voice 1 - FREQ LOW          |
| 0x1001                                      |          | 8    | I/O  | R/W | Voice 1 - FREQ HI           |
| 0x1002                                      |          | 8    | I/O  | R/W | Voice 1 - PW LO             |
| 0x1003                                      |          | 8    | I/O  | R/W | Voice 1 - PW HI             |
| 0x1004                                      |          | 8    | I/O  | R/W | Voice 1 - Control           |
| 0x1005                                      |          | 8    | I/O  | R/W | Voice 1 - Attack / Decay    |
| 0x1006                                      |          | 8    | I/O  | R/W | Voice 1 - Sustain / Release |
| 0x1007                                      |          | 8    | I/O  | R/W | Voice 2 - FREQ LOW          |
| 0x1008                                      |          | 8    | I/O  | R/W | Voice 2 - FREQ HI           |
| 0x1009                                      |          | 8    | I/O  | R/W | Voice 2 - PW LO             |
| 0x100A                                      |          | 8    | I/O  | R/W | Voice 2 - PW HI             |
| 0x100B                                      |          | 8    | I/O  | R/W | Voice 2 - Control           |
| 0x100C                                      |          | 8    | I/O  | R/W | Voice 2 - Attack / Decay    |
| 0x100D                                      |          | 8    | I/O  | R/W | Voice 2 - Sustain / Release |
| 0x100E                                      |          | 8    | I/O  | R/W | Voice 3 - FREQ LOW          |
| 0x100F                                      |          | 8    | I/O  | R/W | Voice 3 - FREQ HI           |
| 0x1010                                      |          | 8    | I/O  | R/W | Voice 3 - PW LO             |
| 0x1011                                      |          | 8    | I/O  | R/W | Voice 3 - PW HI             |
| 0x1012                                      |          | 8    | I/O  | R/W | Voice 3 - Control           |
| 0x1013                                      |          | 8    | I/O  | R/W | Voice 3 - Attack / Decay    |
| 0x1014                                      |          | 8    | I/O  | R/W | Voice 3 - Sustain / Release |
| 0x1015                                      |          | 8    | I/O  | R/W | Filter - FC LOW             |
| 0x1016                                      |          | 8    | I/O  | R/W | Filter - FC HI              |
| 0x1017                                      |          | 8    | I/O  | R/W | Filter - RES / FILT         |
| 0x1018                                      |          | 8    | I/O  | R/W | Filter - Mode / VOL         |
| 0x1019                                      |          | 8    | I/O  | R/W | POT X (not Supported)       |
| 0x101A                                      |          | 8    | I/O  | R/W | POT Y (not Supported)       |
| 0x101B                                      |          | 8    | I/O  | R/W | OSC3 / RANDOM               |
| 0x101C                                      |          | 8    | I/O  | R/W | ENV3                        |
| 0x101D                                      |          | 8    | I/O  | R/W | Reserved                    |
| 0x101E                                      |          | 8    | I/O  | R/W | Reserved                    |
| 0x101F                                      |          | 8    | I/O  | R/W | Reserved                    |
| <b>RIGHT Channel (Registers summarized)</b> |          |      |      |     |                             |
| 0x1200                                      |          | 8    | I/O  | R/W | Voice 1 - FREQ LOW          |
| 0x1201                                      |          | 8    | I/O  | R/W | Voice 1 - FREQ HI           |
| 0x1202                                      |          | 8    | I/O  | R/W | Voice 1 - PW LO             |
| 0x1203                                      |          | 8    | I/O  | R/W | Voice 1 - PW HI             |
| 0x1204                                      |          | 8    | I/O  | R/W | Voice 1 - Control           |
| 0x1205                                      |          | 8    | I/O  | R/W | Voice 1 - Attack / Decay    |
| 0x1206                                      |          | 8    | I/O  | R/W | Voice 1 - Sustain / Release |
| 0x1207                                      |          | 8    | I/O  | R/W | Voice 2 - FREQ LOW          |
| 0x1208                                      |          | 8    | I/O  | R/W | Voice 2 - FREQ HI           |
| 0x1209                                      |          | 8    | I/O  | R/W | Voice 2 - PW LO             |
| 0x120A                                      |          | 8    | I/O  | R/W | Voice 2 - PW HI             |
| 0x120B                                      |          | 8    | I/O  | R/W | Voice 2 - Control           |
| 0x120C                                      |          | 8    | I/O  | R/W | Voice 2 - Attack / Decay    |
| 0x120D                                      |          | 8    | I/O  | R/W | Voice 2 - Sustain / Release |
| 0x120E                                      |          | 8    | I/O  | R/W | Voice 3 - FREQ LOW          |

## A2560 FOENIX K - User Manual

|   |        |   |     |     |   |
|---|--------|---|-----|-----|---|
| 0x120F  |        | 8 | I/O | R/W | Voice 3 - FREQ HI   |
| 0x1210  |        | 8 | I/O | R/W | Voice 3 - PW LO   |
| 0x1211  |        | 8 | I/O | R/W | Voice 3 - PW HI   |
| 0x1212  |        | 8 | I/O | R/W | Voice 3 - Control   |
| 0x1213  |        | 8 | I/O | R/W | Voice 3 - Attack / Decay  |
| 0x1214  |        | 8 | I/O | R/W | Voice 3 - Sustain / Release                                       |
| 0x1215  |        | 8 | I/O | R/W | Filter - FC LOW   |
| 0x1216  |        | 8 | I/O | R/W | Filter - FC HI  |
| 0x1217  |        | 8 | I/O | R/W | Filter - RES / FILT   |
| 0x1218  |        | 8 | I/O | R/W | Filter - Mode / VOL   |
| 0x1219  |        | 8 | I/O | R/W | POT X (not Supported)   |
| 0x121A  |        | 8 | I/O | R/W | POT Y (not Supported)   |
| 0x121B  |        | 8 | I/O | R/W | OSC3 / RANDOM   |
| 0x121C  |        | 8 | I/O | R/W | ENV3  |
| 0x121D  |        | 8 | I/O | R/W | Reserved  |
| 0x121E  |        | 8 | I/O | R/W | Reserved  |
| 0x121F  |        | 8 | I/O | R/W | Reserved  |
| <b>MONO Output R = L (Registers summarized)</b> |        |   |     |     |   |
| 0x1400  | 0x141F | 8 | I/O | R/W | When writing here, both Channels are written to at the same time. |

### 9.2.12. DAC0 Control Registers (48Khz Sampling)

| Addy Start Offset | Addy End | Size | Type | R/W | Description |
|-------------------|----------|------|------|-----|-------------|
| 0x2000            |          | 8    | I/O  | R/W | TBD         |
| 0x2001            |          | 8    | I/O  | R/W | TBD         |
| 0x2002            |          | 8    | I/O  | R/W | TBD         |
| 0x2003            |          | 8    | I/O  | R/W | TBD         |
| 0x2004            |          | 8    | I/O  | R/W | TBD         |
| 0x2005            |          | 8    | I/O  | R/W | TBD         |
| 0x2006            |          | 8    | I/O  | R/W | TBD         |
| 0x2007            |          | 8    | I/O  | R/W | TBD         |

### 1.1.1. DAC1 Control Registers (44.1KHz Sampling)

| Addy Start Offset | Addy End | Size | Type | R/W | Description |
|-------------------|----------|------|------|-----|-------------|
| 0x2100            |          | 8    | I/O  | R/W | TBD         |
| 0x2101            |          | 8    | I/O  | R/W | TBD         |
| 0x2102            |          | 8    | I/O  | R/W | TBD         |
| 0x2103            |          | 8    | I/O  | R/W | TBD         |
| 0x2104            |          | 8    | I/O  | R/W | TBD         |
| 0x2105            |          | 8    | I/O  | R/W | TBD         |
| 0x2106            |          | 8    | I/O  | R/W | TBD         |
| 0x2107            |          | 8    | I/O  | R/W | TBD         |

9.2.13. Internal YM2149 Left Control Registers

| Addy Start Offset | Addy End | Size | Type | R/W | Description |
|-------------------|----------|------|------|-----|-------------|
| 0x3000            |          | 8    | I/O  | R/W | TBD         |
| 0x3001            |          | 8    | I/O  | R/W | TBD         |
| 0x3002            |          | 8    | I/O  | R/W | TBD         |
| 0x3003            |          | 8    | I/O  | R/W | TBD         |
| 0x3004            |          | 8    | I/O  | R/W | TBD         |
| 0x3005            |          | 8    | I/O  | R/W | TBD         |
| 0x3006            |          | 8    | I/O  | R/W | TBD         |
| 0x3007            |          | 8    | I/O  | R/W | TBD         |

9.2.14. Internal YM2149 Right Control Registers

| Addy Start Offset | Addy End | Size | Type | R/W | Description |
|-------------------|----------|------|------|-----|-------------|
| 0x3200            |          | 8    | I/O  | R/W | TBD         |
| 0x3201            |          | 8    | I/O  | R/W | TBD         |
| 0x3202            |          | 8    | I/O  | R/W | TBD         |
| 0x3203            |          | 8    | I/O  | R/W | TBD         |
| 0x3204            |          | 8    | I/O  | R/W | TBD         |
| 0x3205            |          | 8    | I/O  | R/W | TBD         |
| 0x3206            |          | 8    | I/O  | R/W | TBD         |
| 0x3207            |          | 8    | I/O  | R/W | TBD         |

9.2.15. Internal YM2149 ( L = R ) Control Registers

When writing here, both Channels are written to at the same time.

| Addy Start Offset | Addy End | Size | Type | R/W | Description |
|-------------------|----------|------|------|-----|-------------|
| 0x3400            |          | 8    | I/O  | R/W | TBD         |
| 0x3401            |          | 8    | I/O  | R/W | TBD         |
| 0x3402            |          | 8    | I/O  | R/W | TBD         |
| 0x3403            |          | 8    | I/O  | R/W | TBD         |
| 0x3404            |          | 8    | I/O  | R/W | TBD         |
| 0x3405            |          | 8    | I/O  | R/W | TBD         |
| 0x3406            |          | 8    | I/O  | R/W | TBD         |
| 0x3407            |          | 8    | I/O  | R/W | TBD         |



9.3. VICKY III Channel A Address Offset: 0xFEC4:XXXX

9.3.1. Control Registers

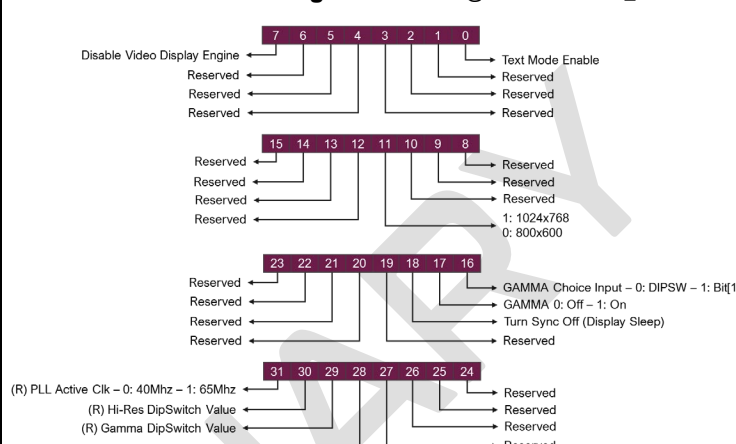
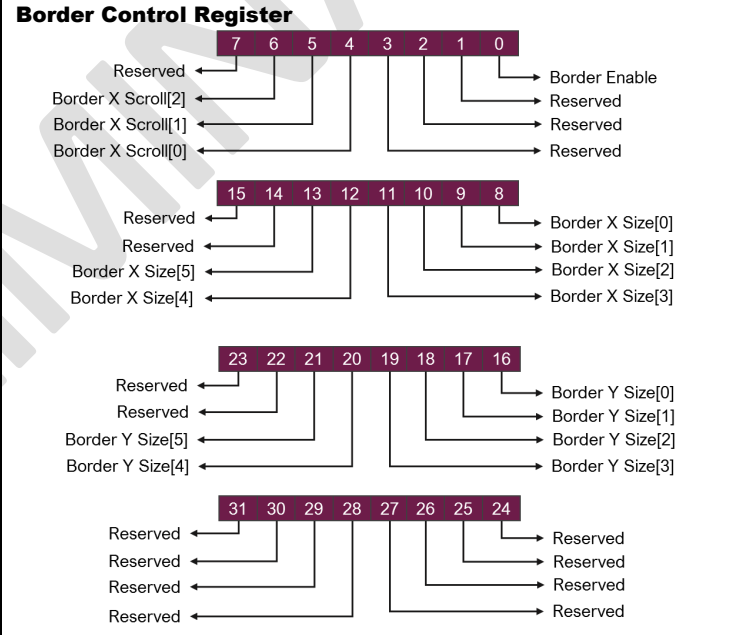
| Addy Start Offset | Addy End | Size | Type | R/W | Description   |
|-------------------|----------|------|------|-----|---|
| 0x0000            |          | 32   | I/O  | R/W | <p><b>VICKY Master Control Register 0</b> Value @ Reset: 0x0000_0001</p>  |
| 0x0004            |          | 32   | I/O  | R/W | <p><b>Border Control Register</b></p>                                    |
| 0x0008            |          | 32   | I/O  | R/W | <b>Border Color Register</b>  |

|               |  |           |            |            |   |
|---------------|--|-----------|------------|------------|---|
|               |  |           |            |            |   |
| <b>0x000C</b> |  | <b>32</b> | <b>I/O</b> | <b>R/W</b> | <p><b>Background Color Register</b></p>   |
| <b>0x0010</b> |  | <b>32</b> | <b>I/O</b> | <b>R/W</b> | <p><b>Cursor Control Register</b></p> <p> <b>Reserved</b> ← [7:0] → <b>Cursor Enable</b><br/> <b>Reserved</b> ← [6:5] → <b>Cursor Flash Rate[0]</b><br/> <b>FONT Size - 0: 8x8 - 1: 8x16**</b> ← [4:3] → <b>Cursor Flash Rate[1]</b><br/> <b>FONT Set[1]**</b> ← [2:1] → <b>FONT Set[0]**</b> </p> <p> <b>X Offset in Char Buffer[7]</b> ← [15:14] → <b>X Offset in Char Buffer[0]</b><br/> <b>X Offset in Char Buffer[6]</b> ← [13:12] → <b>X Offset in Char Buffer[1]</b><br/> <b>X Offset in Char Buffer[5]</b> ← [11:10] → <b>X Offset in Char Buffer[2]</b><br/> <b>X Offset in Char Buffer[4]</b> ← [9:8] → <b>X Offset in Char Buffer[3]</b> </p> <p> <b>Cursor Char Value[7]</b> ← [23:22] → <b>Cursor Char Value[0]</b><br/> <b>Cursor Char Value[6]</b> ← [21:20] → <b>Cursor Char Value[1]</b><br/> <b>Cursor Char Value[5]</b> ← [19:18] → <b>Cursor Char Value[2]</b><br/> <b>Cursor Char Value[4]</b> ← [17:16] → <b>Cursor Char Value[3]</b> </p> <p> <b>Cursor Color FG Value[3]</b> ← [31:30] → <b>Cursor Color BG Value[0]</b><br/> <b>Cursor Color FG Value[2]</b> ← [29:28] → <b>Cursor Color BG Value[1]</b><br/> <b>Cursor Color FG Value[1]</b> ← [27:26] → <b>Cursor Color BG Value[2]</b><br/> <b>Cursor Color FG Value[0]</b> ← [25:24] → <b>Cursor Color BG Value[3]</b> </p> <p><b>** : Not Implemented Yet</b></p> |

|            |     |     |     |     |  |            |     |     |       |   |   |       |   |   |       |   |   |         |   |   |
|------------|-----|-----|-----|-----|--|------------|-----|-----|-------|---|---|-------|---|---|-------|---|---|---------|---|---|
|            |     |     |     |     | <table border="1"> <tr> <td>Flash Rate</td> <td>[1]</td> <td>[0]</td> </tr> <tr> <td>1 Sec</td> <td>0</td> <td>0</td> </tr> <tr> <td>½ sec</td> <td>0</td> <td>1</td> </tr> <tr> <td>¼ sec</td> <td>1</td> <td>0</td> </tr> <tr> <td>1/5 sec</td> <td>1</td> <td>1</td> </tr> </table>   | Flash Rate | [1] | [0] | 1 Sec | 0 | 0 | ½ sec | 0 | 1 | ¼ sec | 1 | 0 | 1/5 sec | 1 | 1 |
| Flash Rate | [1] | [0] |     |     |  |            |     |     |       |   |   |       |   |   |       |   |   |         |   |   |
| 1 Sec      | 0   | 0   |     |     |  |            |     |     |       |   |   |       |   |   |       |   |   |         |   |   |
| ½ sec      | 0   | 1   |     |     |  |            |     |     |       |   |   |       |   |   |       |   |   |         |   |   |
| ¼ sec      | 1   | 0   |     |     |  |            |     |     |       |   |   |       |   |   |       |   |   |         |   |   |
| 1/5 sec    | 1   | 1   |     |     |  |            |     |     |       |   |   |       |   |   |       |   |   |         |   |   |
| 0x0014     |     | 32  | I/O | R/W | <p><b>Cursor Position Register</b></p> <p>The diagram shows a 32-bit register divided into four 8-bit sections. The first section (bits 7-0) is for Cursor X Pos Value, with bit 7 being the most significant and bit 0 the least. The second section (bits 15-8) is also for Cursor X Pos Value, with bit 15 being the most significant and bit 8 the least. The third section (bits 23-16) is for Cursor Y Pos Value, with bit 23 being the most significant and bit 16 the least. The fourth section (bits 31-24) is also for Cursor Y Pos Value, with bit 31 being the most significant and bit 24 the least.</p>                                      |            |     |     |       |   |   |       |   |   |       |   |   |         |   |   |
| 0x0018     |     | 32  | I/O | R/W | <p><b>Line Interrupt Register 0 &amp; Line Interrupt Register 1</b></p> <p>The diagram shows a 32-bit register divided into four 8-bit sections. The first section (bits 7-0) is for Line Interrupt Register 0, with bit 7 being the most significant and bit 0 the least. The second section (bits 15-8) is for Line Compare Value, with bit 15 being the most significant and bit 8 the least. The third section (bits 23-16) is for Line Interrupt Register 1, with bit 23 being the most significant and bit 16 the least. The fourth section (bits 31-24) is for Line Compare Value, with bit 31 being the most significant and bit 24 the least.</p> |            |     |     |       |   |   |       |   |   |       |   |   |         |   |   |
| 0x001C     |     | 32  | I/O | R/W | <p><b>Line Interrupt Register 2 &amp; Line Interrupt Register 3</b></p> <p>The diagram shows a 32-bit register divided into four 8-bit sections. The first section (bits 7-0) is for Line Interrupt Register 2, with bit 7 being the most significant and bit 0 the least. The second section (bits 15-8) is for Line Compare Value, with bit 15 being the most significant and bit 8 the least. The third section (bits 23-16) is for Line Interrupt Register 3, with bit 23 being the most significant and bit 16 the least. The fourth section (bits 31-24) is for Line Compare Value, with bit 31 being the most significant and bit 24 the least.</p> |            |     |     |       |   |   |       |   |   |       |   |   |         |   |   |

|                      |  |                  |                   |                   |                              |
|----------------------|--|------------------|-------------------|-------------------|------------------------------|
| <p><b>0x0020</b></p> |  | <p><b>32</b></p> | <p><b>I/O</b></p> | <p><b>R/W</b></p> | <p><b>FONT Manager 0</b></p> |
| <p><b>0x0024</b></p> |  | <p><b>32</b></p> | <p><b>I/O</b></p> | <p><b>R/W</b></p> | <p><b>FONT Manager 1</b></p> |
| <p><b>0x0028</b></p> |  | <p><b>32</b></p> | <p><b>I/O</b></p> | <p><b>R/W</b></p> | <p><b>Reserved</b></p>       |
| <p><b>0x002C</b></p> |  | <p><b>32</b></p> | <p><b>I/O</b></p> | <p><b>R/W</b></p> | <p><b>Reserved</b></p>       |
| <p><b>0x0030</b></p> |  | <p><b>32</b></p> | <p><b>I/O</b></p> | <p><b>R/W</b></p> | <p><b>Reserved</b></p>       |
| <p><b>0x0034</b></p> |  | <p><b>32</b></p> | <p><b>I/O</b></p> | <p><b>R/W</b></p> | <p><b>Reserved</b></p>       |
| <p><b>0x0038</b></p> |  | <p><b>32</b></p> | <p><b>I/O</b></p> | <p><b>R/W</b></p> | <p><b>Reserved</b></p>       |
| <p><b>0x003C</b></p> |  | <p><b>32</b></p> | <p><b>I/O</b></p> | <p><b>R/W</b></p> | <p><b>Reserved</b></p>       |

### 9.3.2. Mouse Graphic Memory

| Addy Start Offset | Addy End | Size | Type | R/W | Description  |
|-------------------|----------|------|------|-----|--|
| 0x0400            | 0x0BFF   | 32   | MEM  | W   | 16x16 - ARGB - Full color Mouse Pointer Memory Pointer |

### 9.3.3. Mouse Control Registers

| Addy Start Offset | Addy End | Size | Type | R/W        | Description  |
|-------------------|----------|------|------|------------|--|
| 0x0C00            |          |      | I/O  | R32<br>W16 | <b>Mouse Pointer Control Register</b>                    |
| 0x0C02            |          |      | I/O  | W16        | Reserved   |
| 0x0C04            |          |      | I/O  | R32        | Mouse Ptr Y Position [15:0], Mouse Ptr X Position [15:0] |
| 0x0C06            |          |      | I/O  | W16        | Reserved   |
| 0x0C08            |          |      | I/O  | R32        | PS2 Mouse Byte 0[31:16], 0x0000                          |
| 0x0C0A            |          |      | I/O  | W16        | PS2 Mouse Byte 0   |
| 0x0C0C            |          |      | I/O  | R32        | PS2 Mouse Byte 2[31:16], PS2 Mouse Byte 1[15:0]          |
| 0x0C0C            |          |      | I/O  | W16        | PS2 Mouse Byte 1   |
| 0x0C0E            |          |      | I/O  | W16        | PS2 Mouse Byte 2   |

PRELIMINARY

### 9.3.4. GAMMA Memory Block

| Addy Start Offset | Addy End | Size | Type | R/W | Description                    |
|-------------------|----------|------|------|-----|--------------------------------|
| 0x4000            | 0x40FF   | 8    | MEM  | R/W | GAMMA Correction Blue Channel  |
| 0x4100            | 0x41FF   | 8    | MEM  | R/W | GAMMA Correction Green Channel |
| 0x4200            | 0x42FF   | 8    | MEM  | R/W | GAMMA Correction Red Channel   |

### 9.3.5. FONT Memory Block

| Addy Start Offset | Addy End | Size | Type | R/W | Description                     |
|-------------------|----------|------|------|-----|---------------------------------|
| 0x8000            | 0x8FFF   | 8    | MEM  | R/W | FONT Character Graphics Storage |

## 9.4. VICKY III Channel A Address Offset: 0xFEC6:XXXX

### 9.4.1. Text Memory Block

| Addy Start Offset | Addy End | Size | Type | R/W | Description                        |
|-------------------|----------|------|------|-----|------------------------------------|
| 0x0000            | 0x3FFF   | 8    | MEM  | R/W | Text Mode Character Display Memory |

### 9.4.2. Text Color Memory Block

| Addy Start Offset | Addy End | Size | Type | R/W | Description                    |
|-------------------|----------|------|------|-----|--------------------------------|
| 0x8000            | 0xBFFF   | 8    | MEM  | R/W | Text Mode Color Display Memory |

### 9.4.3. Text Color LUT

| Addy Start Offset | Addy End | Size | Type | R/W | Description                                  |
|-------------------|----------|------|------|-----|--|
| 0xC400            | 0xC43F   | 32   | MEM  | R/W | 16x 32Bits Values ARGB for Foreground Colors |
| 0xC440            | 0xC47F   | 32   | MEM  | R/W | 16x 32Bits Values ARGB for Background Colors |

9.5. VICKY III Channel B Address Offset: 0xFEC8:XXXX

9.5.1. Control Registers

| Addy Start Offset | Addy End | Size | Type | R/W | Description  |            |     |     |                 |   |   |                 |   |   |          |   |   |                 |   |   |
|-------------------|----------|------|------|-----|--|------------|-----|-----|-----------------|---|---|-----------------|---|---|----------|---|---|-----------------|---|---|
| 0x0000            |          | 32   | I/O  | R/W | <p><b>VICKY Master Control Register 0 Value @ Reset: 0x0000_0001</b></p> <table border="1"> <thead> <tr> <th>Video Mode</th> <th>[1]</th> <th>[0]</th> </tr> </thead> <tbody> <tr> <td>640x480 @ 60FPS</td> <td>0</td> <td>0</td> </tr> <tr> <td>800x600 @ 60FPS</td> <td>0</td> <td>1</td> </tr> <tr> <td>Reserved</td> <td>1</td> <td>0</td> </tr> <tr> <td>640x400 @ 70FPS</td> <td>1</td> <td>1</td> </tr> </tbody> </table> | Video Mode | [1] | [0] | 640x480 @ 60FPS | 0 | 0 | 800x600 @ 60FPS | 0 | 1 | Reserved | 1 | 0 | 640x400 @ 70FPS | 1 | 1 |
| Video Mode        | [1]      | [0]  |      |     |  |            |     |     |                 |   |   |                 |   |   |          |   |   |                 |   |   |
| 640x480 @ 60FPS   | 0        | 0    |      |     |  |            |     |     |                 |   |   |                 |   |   |          |   |   |                 |   |   |
| 800x600 @ 60FPS   | 0        | 1    |      |     |  |            |     |     |                 |   |   |                 |   |   |          |   |   |                 |   |   |
| Reserved          | 1        | 0    |      |     |  |            |     |     |                 |   |   |                 |   |   |          |   |   |                 |   |   |
| 640x400 @ 70FPS   | 1        | 1    |      |     |  |            |     |     |                 |   |   |                 |   |   |          |   |   |                 |   |   |
| 0x0004            |          | 32   | I/O  | R/W | <p><b>Border Control Register</b></p>  |            |     |     |                 |   |   |                 |   |   |          |   |   |                 |   |   |
| 0x0008            |          | 32   | I/O  | R/W | <p><b>Border Color Register</b></p>  |            |     |     |                 |   |   |                 |   |   |          |   |   |                 |   |   |

|                      |  |                  |                   |                   |   |
|----------------------|--|------------------|-------------------|-------------------|---|
|                      |  |                  |                   |                   |   |
| <p><b>0x000C</b></p> |  | <p><b>32</b></p> | <p><b>I/O</b></p> | <p><b>R/W</b></p> | <p><b>Background Color Register</b></p>   |
| <p><b>0x0010</b></p> |  | <p><b>32</b></p> | <p><b>I/O</b></p> | <p><b>R/W</b></p> | <p><b>Cursor Control Register</b></p> <p>Reserved</p> <p>Reserved</p> <p>FONT Size - 0: 8x8 - 1:8x16**</p> <p>FONT Set[1]**</p> <p>X Offset in Char Buffer[7]</p> <p>X Offset in Char Buffer[6]</p> <p>X Offset in Char Buffer[5]</p> <p>X Offset in Char Buffer[4]</p> <p>Cursor Char Value[7]</p> <p>Cursor Char Value[6]</p> <p>Cursor Char Value[5]</p> <p>Cursor Char Value[4]</p> <p>Cursor Color FG Value[3]</p> <p>Cursor Color FG Value[2]</p> <p>Cursor Color FG Value[1]</p> <p>Cursor Color FG Value[0]</p> <p>Cursor Enable</p> <p>Cursor Flash Rate[0]</p> <p>Cursor Flash Rate[1]</p> <p>FONT Set[0]**</p> <p>X Offset in Char Buffer[0]</p> <p>X Offset in Char Buffer[1]</p> <p>X Offset in Char Buffer[2]</p> <p>X Offset in Char Buffer[3]</p> <p>Cursor Char Value[0]</p> <p>Cursor Char Value[1]</p> <p>Cursor Char Value[2]</p> <p>Cursor Char Value[3]</p> <p>Cursor Color BG Value[0]</p> <p>Cursor Color BG Value[1]</p> <p>Cursor Color BG Value[2]</p> <p>Cursor Color BG Value[3]</p> <p>** : Not Implemented Yet</p> |



|               |  |           |            | Flash Rate |   |
|---------------|--|-----------|------------|------------|---|
|               |  |           |            | [1]        | [0]   |
|               |  |           |            | 1 Sec      | 0 0   |
|               |  |           |            | ½ sec      | 0 1   |
|               |  |           |            | ¼ sec      | 1 0   |
|               |  |           |            | 1/5 sec    | 1 1   |
| <b>0x0014</b> |  | <b>32</b> | <b>I/O</b> | <b>R/W</b> | <p><b>Cursor Position Register</b></p> <p>Bit fields for Cursor Position Register:<br/>           Bits 7-0: Cursor X Pos Value[7] to [0]<br/>           Bits 15-8: Cursor X Pos Value[15] to [8]<br/>           Bits 23-16: Cursor Y Pos Value[7] to [0]<br/>           Bits 31-24: Cursor Y Pos Value[15] to [8]</p>   |
| <b>0x0018</b> |  | <b>32</b> | <b>I/O</b> | <b>R/W</b> | <p><b>Line Interrupt Register 0 &amp; Line Interrupt Register 1</b></p> <p>Bit fields for Line Interrupt Register 0:<br/>           Bits 7-0: Line Compare Value[3] to [0], Line Interrupt Enable, Reserved, Reserved, Reserved<br/>           Bits 15-8: Line Compare Value[11] to [8], Line Compare Value[4] to [7]<br/>           Bits 23-16: Line Compare Value[3] to [0], Line Interrupt Enable, Reserved, Reserved, Reserved<br/>           Bits 31-24: Line Compare Value[11] to [8], Line Compare Value[4] to [7]</p> |
| <b>0x001C</b> |  | <b>32</b> | <b>I/O</b> | <b>R/W</b> | <p><b>Line Interrupt Register 2 &amp; Line Interrupt Register 3</b></p> <p>Bit fields for Line Interrupt Register 2:<br/>           Bits 7-0: Line Compare Value[3] to [0], Line Interrupt Enable, Reserved, Reserved, Reserved<br/>           Bits 15-8: Line Compare Value[11] to [8], Line Compare Value[4] to [7]<br/>           Bits 23-16: Line Compare Value[3] to [0], Line Interrupt Enable, Reserved, Reserved, Reserved<br/>           Bits 31-24: Line Compare Value[11] to [8], Line Compare Value[4] to [7]</p> |
| <b>0x0020</b> |  | <b>16</b> | <b>I/O</b> | <b>R/W</b> | <b>Reserved</b>   |
| <b>0x0022</b> |  | <b>16</b> | <b>I/O</b> | <b>R/W</b> | <b>Reserved</b>   |

# A2560 FOENIX K - User Manual

|               |  |           |            |            |                 |
|---------------|--|-----------|------------|------------|-----------------|
| <b>0x0024</b> |  | <b>16</b> | <b>I/O</b> | <b>R/W</b> | <b>Reserved</b> |
| <b>0x0026</b> |  | <b>16</b> | <b>I/O</b> | <b>R/W</b> | <b>Reserved</b> |
| <b>0x0028</b> |  | <b>16</b> | <b>I/O</b> | <b>R/W</b> | <b>Reserved</b> |
| <b>0x002A</b> |  | <b>16</b> | <b>I/O</b> | <b>R/W</b> | <b>Reserved</b> |
| <b>0x002C</b> |  | <b>16</b> | <b>I/O</b> | <b>R/W</b> | <b>Reserved</b> |
| <b>0x002E</b> |  | <b>16</b> | <b>I/O</b> | <b>R/W</b> | <b>Reserved</b> |

PRELIMINARY

### 9.5.2. Bitmap Control Registers

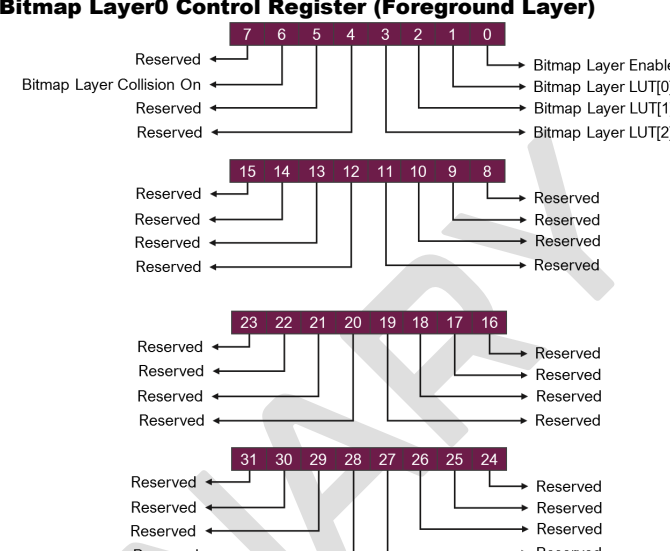
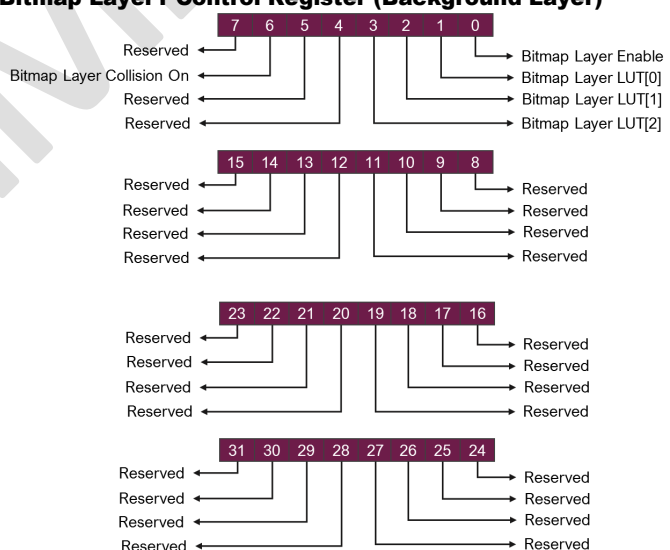
| Addy Start Offset | Addy End | Size | Type | R/W | Description  |
|-------------------|----------|------|------|-----|--|
| 0x0100            |          | 32   | I/O  | R/W | <b>Bitmap Layer0 Control Register (Foreground Layer)</b>   |
| 0x0104            |          | 32   | I/O  | R/W | <b>Bitmap Layer0 VRAM Address Pointer</b><br>Offset within the VRAM memory from VICKY's perspective<br>VRAM Address begins @ \$00:0000 and ends @ \$1FFFFFF<br><i>Always position the bitmap within a 32bits Boundary address.</i> |
| 0x0108            |          | 32   | I/O  | R/W | <b>Bitmap Layer1 Control Register (Background Layer)</b>   |
| 0x000C            |          | 32   | I/O  | R/W | <b>Bitmap Layer1 VRAM Address Pointer</b><br>Offset within the VRAM memory from VICKY's perspective<br>VRAM Address begins @ \$00:0000 and ends @ \$1FFFFFF<br><i>Always position the bitmap within a 32bits Boundary address.</i> |
| 0x0010            |          | 32   | I/O  | R/W | <b>Bitmap Collision Layer Control Register</b> (Not Implemented)   |
| 0x0014            |          | 32   | I/O  | R/W | <b>Bitmap Collision Layer VRAM Address Pointer</b> (Not Implemented)   |

9.5.3. Tile Map Control Registers

| Addy Start Offset | Addy End | Size | Type | R/W | Description   |
|-------------------|----------|------|------|-----|---|
| 0x0200            |          | 16   | I/O  | W   | <p><b>Tile Map Layer0 Control Register (Foreground Layer)</b></p> <p><b>Note:</b> The LUT is defined in each tile Attributes Bit field [13:11]<br/>                     The Tile Set is also defined in each tile Attributes bit field [10:8]<br/>                     The Master Collision bit is defined here, but each tile needs to be turn on for collision control by setting bit [14] in the Tile 16bits definition.</p> |
| 0x0204            |          | 32   | I/O  | W   | <p><b>Tile Map Layer0 VRAM Address Pointer</b><br/>                     Offset within the VRAM memory from VICKY's perspective<br/>                     VRAM Address begins @ \$000000 and ends @ \$1FFFFFF<br/> <i>Always position the Map within a 16bits Boundary address.</i></p>   |
| 0x0208            |          | 16   | I/O  | W   | <p><b>Tile Map Layer0 X Map Size</b></p>  |
| 0x020A            |          | 16   | I/O  | W   | <p><b>Tile Map Layer0 Y Map Size</b></p>  |
| 0x020C            |          | 16   | I/O  | W   | <p><b>Tile Map Layer0 X Position</b></p>  |
| 0x020E            |          | 16   | I/O  | W   | <p><b>Tile Map Layer0 Y Position</b></p>  |

|               |           |            |          |  |  |
|---------------|-----------|------------|----------|--|--|
|               |           |            |          |  |  |
| <b>0x0210</b> | <b>16</b> | <b>I/O</b> | <b>W</b> | <b>Tile Map Layer1 Control Register (Mid-Layer0)</b>   |  |
| <b>0x0214</b> | <b>32</b> | <b>I/O</b> | <b>W</b> | <b>Tile Map Layer1 VRAM Address Pointer</b><br>Offset within the VRAM memory from VICKY's perspective<br>VRAM Address begins @ \$000000 and ends @ \$1FFFFFF<br><i>Always position the Map within a 16bits Boundary address.</i> |  |
| <b>0x0218</b> | <b>16</b> | <b>I/O</b> | <b>W</b> | <b>Tile Map Layer1 X Map Size</b>  |  |
| <b>0x021A</b> | <b>16</b> | <b>I/O</b> | <b>W</b> | <b>Tile Map Layer1 Y Map Size</b>  |  |
| <b>0x021C</b> | <b>16</b> | <b>I/O</b> | <b>W</b> | <b>Tile Map Layer1 X Position</b>  |  |
| <b>0x021E</b> | <b>16</b> | <b>I/O</b> | <b>W</b> | <b>Tile Map Layer1 Y Position</b>  |  |
| <b>0x0220</b> | <b>16</b> | <b>I/O</b> | <b>W</b> | <b>Tile Map Layer2 Control Register (Mid-Layer1)</b>   |  |
| <b>0x0224</b> | <b>32</b> | <b>I/O</b> | <b>W</b> | <b>Tile Map Layer2 VRAM Address Pointer</b><br>Offset within the VRAM memory from VICKY's perspective<br>VRAM Address begins @ \$000000 and ends @ \$1FFFFFF<br><i>Always position the Map within a 16bits Boundary address.</i> |  |
| <b>0x0228</b> | <b>16</b> | <b>I/O</b> | <b>W</b> | <b>Tile Map Layer2 X Map Size</b>  |  |
| <b>0x022A</b> | <b>16</b> | <b>I/O</b> | <b>W</b> | <b>Tile Map Layer2 Y Map Size</b>  |  |
| <b>0x022C</b> | <b>16</b> | <b>I/O</b> | <b>W</b> | <b>Tile Map Layer2 X Position</b>  |  |
| <b>0x022E</b> | <b>16</b> | <b>I/O</b> | <b>W</b> | <b>Tile Map Layer2 Y Position</b>  |  |
| <b>0x0230</b> | <b>16</b> | <b>I/O</b> | <b>W</b> | <b>Tile Map Layer3 Control Register (Background Layer)</b>   |  |
| <b>0x0234</b> | <b>32</b> | <b>I/O</b> | <b>W</b> | <b>Tile Map Layer3 VRAM Address Pointer</b><br>Offset within the VRAM memory from VICKY's perspective<br>VRAM Address begins @ \$000000 and ends @ \$1FFFFFF<br><i>Always position the Map within a 16bits Boundary address.</i> |  |
| <b>0x0238</b> | <b>16</b> | <b>I/O</b> | <b>W</b> | <b>Tile Map Layer3 X Map Size</b>  |  |
| <b>0x023A</b> | <b>16</b> | <b>I/O</b> | <b>W</b> | <b>Tile Map Layer3 Y Map Size</b>  |  |
| <b>0x023C</b> | <b>16</b> | <b>I/O</b> | <b>W</b> | <b>Tile Map Layer3 X Position</b>  |  |
| <b>0x023E</b> | <b>16</b> | <b>I/O</b> | <b>W</b> | <b>Tile Map Layer3 Y Position</b>  |  |
| <b>0x0280</b> | <b>32</b> | <b>I/O</b> | <b>W</b> | <b>Tile Graphics Set Addy Pointer 0</b>  |  |
| <b>0x0284</b> | <b>32</b> | <b>I/O</b> | <b>W</b> | <b>Tile Graphics Set Addy Pointer 1</b>  |  |

|               |  |           |            |          |   |
|---------------|--|-----------|------------|----------|---|
| <b>0x0288</b> |  | <b>32</b> | <b>I/O</b> | <b>W</b> | <b>Tile Graphics Set Addy Pointer 2</b> |
| <b>0x028C</b> |  | <b>32</b> | <b>I/O</b> | <b>W</b> | <b>Tile Graphics Set Addy Pointer 3</b> |
| <b>0x0290</b> |  | <b>32</b> | <b>I/O</b> | <b>W</b> | <b>Tile Graphics Set Addy Pointer 4</b> |
| <b>0x0294</b> |  | <b>32</b> | <b>I/O</b> | <b>W</b> | <b>Tile Graphics Set Addy Pointer 5</b> |
| <b>0x0298</b> |  | <b>32</b> | <b>I/O</b> | <b>W</b> | <b>Tile Graphics Set Addy Pointer 6</b> |
| <b>0x029C</b> |  | <b>32</b> | <b>I/O</b> | <b>W</b> | <b>Tile Graphics Set Addy Pointer 7</b> |

PRELIMINARY

#### 9.5.4. Collision Status Registers

| Addy Start Offset | Addy End | Size | Type | R/W | Description      |
|-------------------|----------|------|------|-----|------------------|
| 0x0300            | 0x03FF   | 16   | I/O  | W   | To Be documented |

PRELIMINARY

### 9.5.5. Mouse Pointer Graphic Memory

| Addy Start Offset | Addy End | Size | Type | R/W | Description  |
|-------------------|----------|------|------|-----|--|
| 0x0400            | 0x0BFF   | 32   | MEM  | W   | 16x16 - ARGB - Full color Mouse Pointer Memory Pointer |

### 9.5.6. Mouse Control Registers

| Addy Start Offset | Addy End | Size | Type | R/W        | Description  |
|-------------------|----------|------|------|------------|--|
| 0x0C00            |          |      | I/O  | R32<br>W16 | <b>Mouse Pointer Control Register</b>                    |
| 0x0C02            |          |      | I/O  | W16        | Reserved   |
| 0x0C04            |          |      | I/O  | R32        | Mouse Ptr Y Position [15:0], Mouse Ptr X Position [15:0] |
| 0x0C06            |          |      | I/O  | W16        | Reserved   |
| 0x0C08            |          |      | I/O  | R32        | PS2 Mouse Byte 0[31:16], 0x0000                          |
| 0x0C0A            |          |      | I/O  | W16        | PS2 Mouse Byte 0   |
| 0x0C0C            |          |      | I/O  | R32        | PS2 Mouse Byte 2[31:16], PS2 Mouse Byte 1[15:0]          |
| 0x0C0C            |          |      | I/O  | W16        | PS2 Mouse Byte 1   |
| 0x0C0E            |          |      | I/O  | W16        | PS2 Mouse Byte 2   |



### 9.5.7. Sprites Control Registers

| Addy Start Offset | Addy End | Size | Type | R/W | Description  |
|-------------------|----------|------|------|-----|--|
| 0x1000            |          | 16   | I/O  | W   | <b>Sprite 0 Control Register + Pointer Addy Low – Top Priority</b><br>   |
| 0x1002            |          | 16   | I/O  | W   | <b>Sprite 0 Graphics Pointer Addy (Hi Part)</b><br><p><i>Always position the Pointer within a 16bits Boundary address.</i></p> |
| 0x1004            |          | 16   | I/O  | W   | <b>Sprite 0 X Position</b><br><b>Note:</b> The position 0,0 of a sprite is -32, -32 offscreen                                  |
| 0x1006            |          | 16   | I/O  | W   | <b>Sprite 0 Y Position</b><br><b>Note:</b> The position 0,0 of a sprite is -32, -32 offscreen                                  |
| 0x1008            | 0x100E   | 16   | I/O  | W   | <b>Sprite 1</b>  |
| 0x1010            | 0x1016   | 16   | I/O  | W   | <b>Sprite 2</b>  |
| 0x1018            | 0x101E   | 16   | I/O  | W   | <b>Sprite 3</b>  |
| 0x1020            | 0x1026   | 16   | I/O  | W   | <b>Sprite 4</b>  |
| 0x1028            | 0x102E   | 16   | I/O  | W   | <b>Sprite 5</b>  |
| 0x1030            | 0x1036   | 16   | I/O  | W   | <b>Sprite 6</b>  |
| 0x1038            | 0x103E   | 16   | I/O  | W   | <b>Sprite 7</b>  |
| 0x1040            | 0x1046   | 16   | I/O  | W   | <b>Sprite 8</b>  |
| 0x1048            | 0x104E   | 16   | I/O  | W   | <b>Sprite 9</b>  |
| 0x1050            | 0x1056   | 16   | I/O  | W   | <b>Sprite 10</b>   |
| 0x1058            | 0x105E   | 16   | I/O  | W   | <b>Sprite 11</b>   |
| 0x1060            | 0x1066   | 16   | I/O  | W   | <b>Sprite 12</b>   |
| 0x1068            | 0x106E   | 16   | I/O  | W   | <b>Sprite 13</b>   |
| 0x1070            | 0x1076   | 16   | I/O  | W   | <b>Sprite 14</b>   |
| 0x1078            | 0x107E   | 16   | I/O  | W   | <b>Sprite 15</b>   |
| 0x1080            | 0x1086   | 16   | I/O  | W   | <b>Sprite 16</b>   |
| 0x1088            | 0x108E   | 16   | I/O  | W   | <b>Sprite 17</b>   |
| 0x1090            | 0x1096   | 16   | I/O  | W   | <b>Sprite 18</b>   |
| 0x1098            | 0x109E   | 16   | I/O  | W   | <b>Sprite 19</b>   |
| 0x10A0            | 0x10A6   | 16   | I/O  | W   | <b>Sprite 20</b>   |
| 0x10A8            | 0x10AE   | 16   | I/O  | W   | <b>Sprite 21</b>   |
| 0x10B0            | 0x10B6   | 16   | I/O  | W   | <b>Sprite 22</b>   |
| 0x10B8            | 0x10BE   | 16   | I/O  | W   | <b>Sprite 23</b>   |
| 0x10C0            | 0x10C6   | 16   | I/O  | W   | <b>Sprite 24</b>   |
| 0x10C8            | 0x10CE   | 16   | I/O  | W   | <b>Sprite 25</b>   |
| 0x10D0            | 0x10D6   | 16   | I/O  | W   | <b>Sprite 26</b>   |
| 0x10D8            | 0x10DE   | 16   | I/O  | W   | <b>Sprite 27</b>   |
| 0x10E0            | 0x10E6   | 16   | I/O  | W   | <b>Sprite 28</b>   |
| 0x10E8            | 0x10EE   | 16   | I/O  | W   | <b>Sprite 29</b>   |
| 0x10F0            | 0x10F6   | 16   | I/O  | W   | <b>Sprite 30</b>   |

# A2560 FOENIX K - User Manual

|        |        |    |     |   |                            |
|--------|--------|----|-----|---|----------------------------|
| 0x10F8 | 0x10FE | 16 | I/O | W | Sprite 31                  |
| 0x1100 | 0x1106 | 16 | I/O | W | Sprite 32                  |
| 0x1108 | 0x110E | 16 | I/O | W | Sprite 33                  |
| 0x1110 | 0x1116 | 16 | I/O | W | Sprite 34                  |
| 0x1118 | 0x111E | 16 | I/O | W | Sprite 35                  |
| 0x1120 | 0x1126 | 16 | I/O | W | Sprite 36                  |
| 0x1128 | 0x112E | 16 | I/O | W | Sprite 37                  |
| 0x1130 | 0x1136 | 16 | I/O | W | Sprite 38                  |
| 0x1138 | 0x113E | 16 | I/O | W | Sprite 39                  |
| 0x1140 | 0x1146 | 16 | I/O | W | Sprite 40                  |
| 0x1148 | 0x114E | 16 | I/O | W | Sprite 41                  |
| 0x1150 | 0x1156 | 16 | I/O | W | Sprite 42                  |
| 0x1158 | 0x115E | 16 | I/O | W | Sprite 43                  |
| 0x1160 | 0x1166 | 16 | I/O | W | Sprite 44                  |
| 0x1168 | 0x116E | 16 | I/O | W | Sprite 45                  |
| 0x1170 | 0x1176 | 16 | I/O | W | Sprite 46                  |
| 0x1178 | 0x117E | 16 | I/O | W | Sprite 47                  |
| 0x1180 | 0x1186 | 16 | I/O | W | Sprite 48                  |
| 0x1188 | 0x118E | 16 | I/O | W | Sprite 49                  |
| 0x1190 | 0x1196 | 16 | I/O | W | Sprite 50                  |
| 0x1198 | 0x119E | 16 | I/O | W | Sprite 51                  |
| 0x11A0 | 0x11A6 | 16 | I/O | W | Sprite 52                  |
| 0x11A8 | 0x11AE | 16 | I/O | W | Sprite 53                  |
| 0x11B0 | 0x11B6 | 16 | I/O | W | Sprite 54                  |
| 0x11B8 | 0x11BE | 16 | I/O | W | Sprite 55                  |
| 0x11C0 | 0x11C6 | 16 | I/O | W | Sprite 56                  |
| 0x11C8 | 0x11CE | 16 | I/O | W | Sprite 57                  |
| 0x11D0 | 0x11D6 | 16 | I/O | W | Sprite 58                  |
| 0x11D8 | 0x11DE | 16 | I/O | W | Sprite 59                  |
| 0x11E0 | 0x11E6 | 16 | I/O | W | Sprite 60                  |
| 0x11E8 | 0x11EE | 16 | I/O | W | Sprite 61                  |
| 0x11F0 | 0x11F6 | 16 | I/O | W | Sprite 62                  |
| 0x11F8 | 0x11FE | 16 | I/O | W | Sprite 63 – Least Priority |

### 9.5.8. LUT Memory Block

| Addy Start Offset | Addy End | Size | Type | R/W | Description  |
|-------------------|----------|------|------|-----|--|
| 0x2000            | 0x23FF   | 8    | MEM  | R/W | LUT0 – 256x 32bits ARGB – Offset 0 is always Transparent |
| 0x2400            | 0x27FF   | 8    | MEM  | R/W | LUT1 – 256x 32bits ARGB                                  |
| 0x2800            | 0x2BFF   | 8    | MEM  | R/W | LUT2 – 256x 32bits ARGB                                  |
| 0x2C00            | 0x2FFF   | 8    | MEM  | R/W | LUT3 – 256x 32bits ARGB                                  |
| 0x3000            | 0x33FF   | 8    | MEM  | R/W | LUT4 – 256x 32bits ARGB                                  |
| 0x3400            | 0x37FF   | 8    | MEM  | R/W | LUT5 – 256x 32bits ARGB                                  |
| 0x3800            | 0x3BFF   | 8    | MEM  | R/W | LUT6 – 256x 32bits ARGB                                  |
| 0x3C00            | 0x3FFF   | 8    | MEM  | R/W | LUT7 – 256x 32bits ARGB                                  |

### 9.5.9. GAMMA LUT Memory Block

| Addy Start Offset | Addy End | Size | Type | R/W | Description                    |
|-------------------|----------|------|------|-----|--------------------------------|
| 0x4000            | 0x40FF   | 8    | MEM  | R/W | GAMMA Correction Blue Channel  |
| 0x4100            | 0x41FF   | 8    | MEM  | R/W | GAMMA Correction Green Channel |
| 0x4200            | 0x42FF   | 8    | MEM  | R/W | GAMMA Correction Red Channel   |

### 9.5.10. FONT Memory Block

| Addy Start Offset | Addy End | Size | Type | R/W | Description                     |
|-------------------|----------|------|------|-----|---------------------------------|
| 0x8000            | 0x8FFF   | 8    | MEM  | R/W | FONT Character Graphics Storage |

## 9.6. VICKY III Channel B Address Offset: 0xFECA:XXXX

### 9.6.1. Text Memory Block

| Addy Start Offset | Addy End | Size | Type | R/W | Description                        |
|-------------------|----------|------|------|-----|------------------------------------|
| 0x0000            | 0x3FFF   | 8    | MEM  | R/W | Text Mode Character Display Memory |

### 9.6.2. Text Color Memory Block

| Addy Start Offset | Addy End | Size | Type | R/W | Description                    |
|-------------------|----------|------|------|-----|--------------------------------|
| 0x8000            | 0xBFFF   | 8    | MEM  | R/W | Text Mode Color Display Memory |

### 9.6.3. Text Color LUT

| Addy Start Offset | Addy End | Size | Type | R/W | Description                                  |
|-------------------|----------|------|------|-----|--|
| 0xC400            | 0xC43F   | 32   | MEM  | R/W | 16x 32Bits Values ARGB for Foreground Colors |
| 0xC440            | 0xC47F   | 32   | MEM  | R/W | 16x 32Bits Values ARGB for Background Colors |

PRELIMINARY